





iGEM Bonn



NRP-UEA iGEM

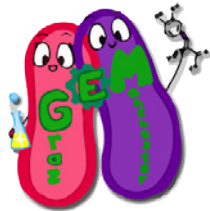

iGEM Manchester-Graz



iGEM Evry



iGEM Vanderbilt



iGEM Minnesota

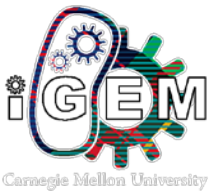

Carnegie Mellon iGEM



iGEM Sydney



UIUC iGEM



iGEM York



iGEM Toulouse



iGEM Pasteur



UCLA iGEM



iGEM Stockholm

# Preface

The cloning guide which is lying before you or on your desktop is a document brought to you by iGEM TU Eindhoven in collaboration with numerous iGEM (International Genetically Engineered Machine) teams during iGEM 2015. An important part in the iGEM competition is the collaboration of your own team with other teams. These collaborations are fully in line with the dedications of the iGEM Foundation on education and competition, the advancement of synthetic biology, and the development of an open community and collaboration. Collaborations between groups of (undergrad and overgrad) students can lead to nice products, as we have tried to provide one for you in 2015.

In order to compile a cloning guide, several iGEM teams from all over the world have been contacted to cooperate on this. Finally fifteen teams contributed in a fantastic way and a cloning guide consisting of the basics about nine different cloning methods and experiences of teams working with them has been realized. Without the help of all collaborating teams this guide could never have been realized, so we will thank all teams in advance.

This guide may be of great help when new iGEM teams (edition 2016 and later) are at the point of designing their project. How to assemble the construct for you project, is an important choice which is possibly somewhat easier to make after reading this guide. We, all the collaborating teams, hope that you read this cloning guide with a lot of interest. We wish you a lot of succes with the iGEM project and don't forget to have a lot of fun in the meantime!

iGEM TU Eindhoven	NRP-UEA iGEM
iGEM Bonn	iGEM Evry
iGEM Manchester-Graz	iGEM Minnesota
iGEM Vanderbilt	iGEM Sydney
Carnegie Mellon iGEM	iGEM York
UIUC iGEM	iGEM Pasteur
iGEM Toulouse	iGEM Stockholm
UCLA iGEM	

*Kind regards,*

*TU Eindhoven*



# Introduction

In November 1973, a paper published by Stanley Cohen and Herb Boyer marked the start of biotechnology. The paper described a way to construct new functional bacterial plasmids in vitro, which we now know as traditional cloning or DNA Recombinant Technology [1]. This fundamental discovery by Cohen and Boyer paved the way for biotechnology and synthetic biology as we know it today. But cloning has not stood still over the last forty-some years. Many efforts have been undertaken to improve upon the traditional cloning methods as described by Cohen and Boyer. These efforts have resulted in numerous different well-known cloning techniques, including standardizations as 3A Assembly & MoClo.

Research to diversify upon the available cloning methods has moved on apace over the last ten years. These research efforts have resulted in cloning methods vastly different from traditional cloning. Currently, cloning methods have been described which are independent of ligation, independent of restriction enzymes and even cloning methods independent of the use of a chassis [2]. These newly developed methods have also found their way into iGEM, providing viable alternatives to the seemingly ancient method of 3A Assembly. Previous Cambridge teams have for example pioneered Gibson Assembly, Freiburg has introduced iGEM to the Golden Gate Standard, and Lethbridge familiarized iGEM with ligation-independent cloning.

Recently, many companies active in biotechnology have begun to offer iGEM teams with products ideally used in combination with these novel cloning methods. Integrated DNA Technologies' gBlocks are ideal for Gibson Assembly and New England Biolabs provides iGEM teams with a choice in cloning kits, including kits for BioBricking, Golden Gate Assembly and Gibson Assembly.

Novel cloning methods have thus started to play a major role within the iGEM competition, and we think that they will become even more important in the future. However, as a new iGEM team still unfamiliar with DNA Recombinant technology, let alone those newer cloning methods, we couldn't see the forest for the trees. In the end, we settled for a combination of Gibson Assembly & BioBricking, which will probably do just fine. But to enable future iGEM teams to make a more informed choice on assembly methods, we thought of compiling a cloning guide.

We cannot hope that the cloning guide can walk iGEM teams through all the ins and outs of molecular cloning: Sambrook and Russel do this in *Molecular Cloning: a laboratory manual*, widely regarded as the bible of biology, but also three volumes thick... However we do hope, the cloning guide can serve as a stepping stone for future iGEM teams in finding their cloning method of choice. To be able to compile a cloning guide which can serve as a stepping stone for future iGEM teams, we rely heavily on collaborations with other teams. Therefore, we have reached out to many other iGEM teams on this guide, who have hands-on experience with many different cloning methods and have tinkered with their protocols.

Kind regards,

TU Eindhoven



# Table of contents

1. Preface.....	3
2. Introduction.....	5
3. Table of contents.....	7
4. Traditional Cloning.....	9
4.1 Manchester-Graz.....	12
4.2 Vanderbilt.....	15
4.3 Carnegie Mellon.....	18
5. 3A Assembly .....	20
5.1 UIUC.....	23
6. Gibson Assembly.....	26
- 6.1 TU Eindhoven.....	30
- 6.2 Paris Pasteur.....	33
- 6.3 York.....	35
7. In-Fusion Cloning.....	38
- 7.1 Toulouse.....	41
8. Iterative Capped Assembly.....	44
- 8.1 UCLA.....	49
9. Golden Gate Assembly.....	52
- 9.1 NRP-UEA.....	55
- 9.2 Evry.....	58
- 9.3 Sydney.....	61
10. Yeast Recombination.....	64
- 10.1 Minnesota.....	67
11. TOPO-TA.....	69
- 11.1 Bonn.....	72
12. Overlap Extension PCR .....	73
- 12.1 Stockholm.....	76

# Traditional Cloning

## Introduction

Experiments in the early 1950's showed different growth behavior of bacteriophage  $\lambda$  depending on which *E. coli* strain was used as a host. First, the reason for this phenomenon was unclear. However in the 1960s it was shown that this strain restriction is caused by an enzymatic cleavage of the phage DNA, that in contrary to the bacterial DNA used a different methylation pattern of its genome and was thus recognized by certain endonucleases. These first so called restriction enzymes were type I restriction endonucleases which means that they cleave the DNA not directly at its recognition site. However in 1970 also type II restriction enzymes were found, which cleave the DNA at its recognition site and therefore were way more suitable for scientific research. The discovery and characterization of restriction enzymes not only marked the beginning of recombinant DNA technology but was also awarded with a Nobel Prize in 1978.

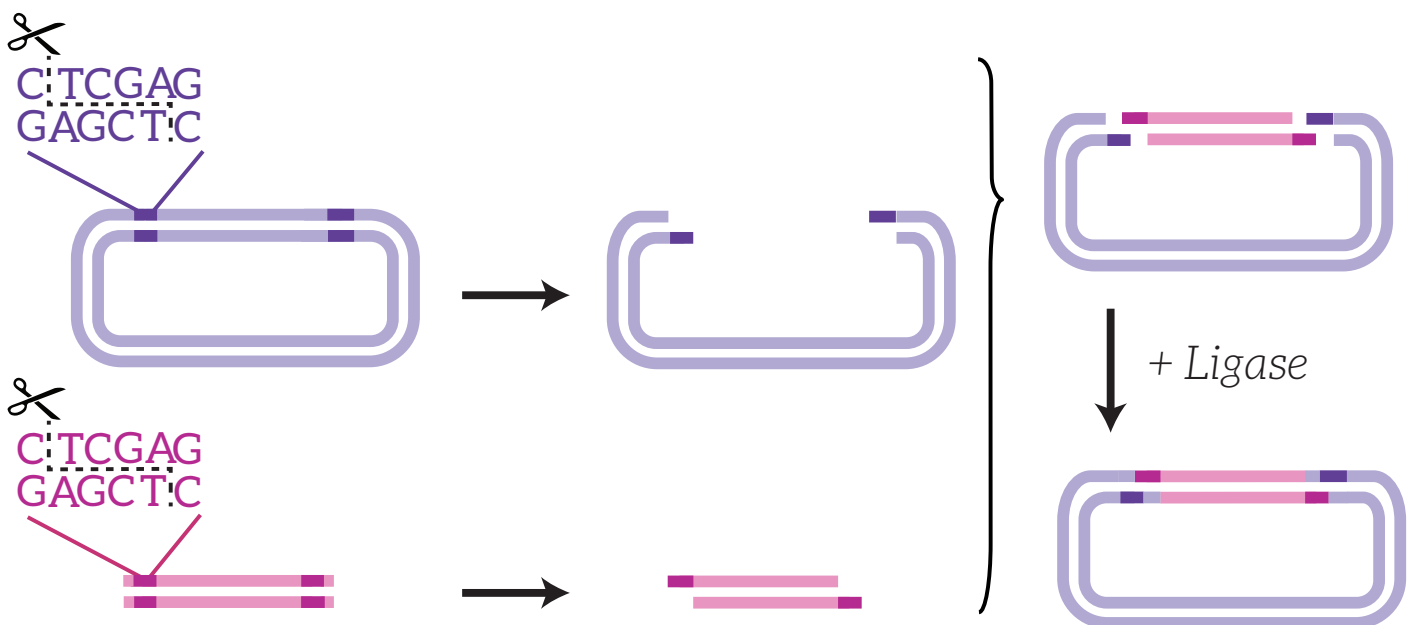

Figure 1: Traditional cloning workflow: restriction digestions of vector backbone (purple) and gene of interest (pink) yields fragments with sticky ends. These fragments can be ligated using T4-ligase.

## Workflow

Traditional cloning (See Figure 1) is a method to clone a gene of interest into a vector of choice. For a successful cloning, both the vector and the insert have to be digested with compatible restriction enzymes to create complementary overhangs. By using restriction enzymes that create different overhangs the gene of interest can be cloned into the vector in a specific direction. The resulting complementary sticky ends can anneal and ligate by T4 ligase to create a circular vector, containing the gene of interest, which can be transformed into competent cells. To increase cloning efficiency the vector backbone typically gets dephosphorylated, preventing self-ligation of the vector, as the 5' phosphate group is catalytically required by the T4 ligase.



## The Cutters

Traditional cloning is based on restriction endonucleases, enzymes that cut DNA at specific recognition sites [1]. Usually type II restriction enzymes (Figure 2) are used which cut the DNA inside a specific palindromic recognition sequence. The way restriction enzymes cut DNA can differ in the following ways [2]:

- Blunt end cutters: Enzymes that cut DNA creating no overhangs, so called blunt ends.
- Sticky end cutters: Enzymes that cut the double stranded target DNA at different positions creating short overhangs of 1 to 4 nucleotides, so called sticky ends.



Figure 2 - Recognition sequences of Type II restriction enzymes with cut sites in pink. Type II restriction enzymes either yield (A) blunt ends or (B) sticky ends.

## Points of interest

- Traditional cloning requires a linearized and dephosphorylated vector to prevent self-ligation.
- The vector is linearized by restriction digestion.
- The linear insert needs short complementary overhangs to the vector provided by restriction digestion.
- Restriction digest with different restriction enzymes leads to directed insertion of the fragments.
- Over 600 restriction enzymes are commercially available.
- When using a restriction enzyme, you should always consider the heat inactivation temperature as well as the buffer in which the enzyme works.

## Advantages

- Easy to use.
- Easy to troubleshoot.
- Relatively cheap.

## Disadvantages

- Need for the respective restriction sites.
- Restriction sites cannot occur somewhere else on the vector or gene of interest.
- Quite laborious.
- Cannot change multiple parts in one instance.
- Relatively low efficiency.

## Frequently Asked Questions

- *What if my Gene of Interest (GOI) is not flanked by the desired restriction sites?*  
You can always attach additional restriction sites with the use of PCR. Design complementary primers to your 5' ends and add the restriction site of your choice as well as 4-6 random nucleotides to allow the endonuclease to properly bind the DNA.
- *How long should I digest my DNA with common restriction enzymes?*  
10 units enzyme are typically enough to digest 1 µg of DNA within an hour at 37°C. This time can be reduced or prolonged depending on the respective enzyme used. Even though most commonly used restriction enzymes only recognize a specific sequence, too long incubation can result in so called star-activity, meaning that unspecific sequences also get cleaved.
- *Do I always need sticky ends?*  
You can also do blunt end cloning. For example synthesized gBlocks typically come with blunt ends and can be cloned into vectors that were also cleaved with restriction enzymes that produce blunt-ends. However, blunt-end cloning typically is less efficient than sticky-end cloning and the direction of the gBlock is random.
- *Can I use the same sticky ends at both ends of my gene of interest?*  
Yes, however this way the direction of the inserted DNA-fragment is random. Two different overhangs allow you to clone your gene of interest in a defined direction.

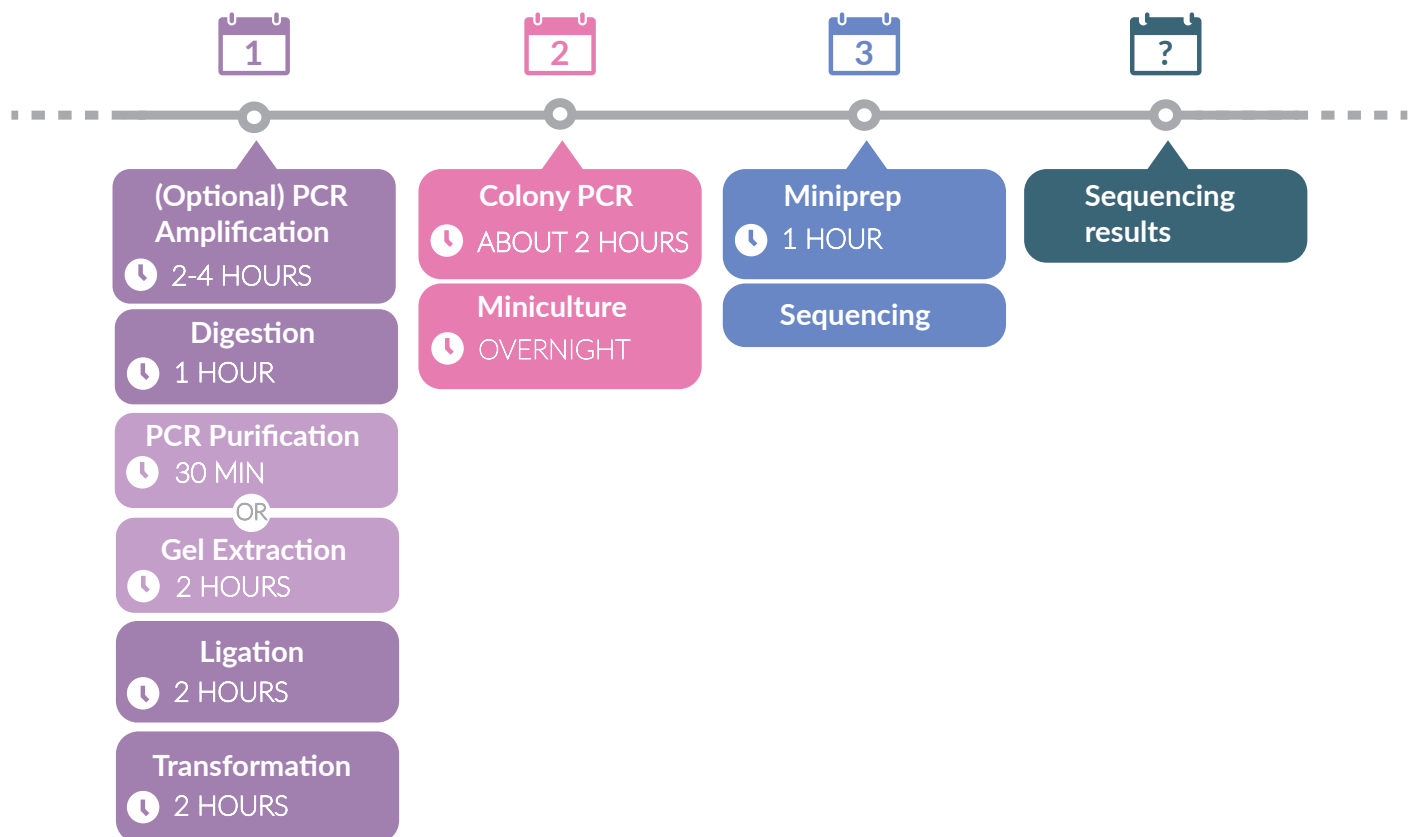

Figure 3 - Schedule of traditional cloning. Traditional cloning starts with PCR amplification of the insert if there is too little available. Next, these parts are digested with the appropriate digestion enzymes. Based on the fragments which are removed from the vector or inserts, the parts can be purified through either gel extraction or PCR purification. The vector and insert can then be ligated into the new vector. The vector can then be transformed for plasmid amplification.

## Further applications

- *Constriction of PCR Product Library*

When creating a library of PCR products, other methods of assembly would be far too complicated and take too long. Blunt ligation solves that problem through the use of the pJET plasmid. The product generated by Pfu DNA polymerases generates a blunt end which can then be ligated with the pJET vector which is also cut with a blunt end. Alternatively, when using a Taq DNA polymerase, there is an adenine base that is added to the 3' end of both strands creating a short overhang. The TOPO backbone is then used for ligation which has a complementary thymine base at the 5' end of both strands. The only issue with these methods is that directionality cannot be specified so insertion is random and can only be determined by sequencing.

- *Short dsDNA Insertion by Annealing Oligos*

Single stranded oligonucleotides can be ordered and then annealed very easily using a simple thermocycler program into a double stranded piece of DNA. Good design beforehand also allows the inclusion of overhang that would create sticky ends compatible with the other digested sequences. This allows for the inclusion of short sequences (<80 bp) into a plasmid without ordering expensive dsDNA and gBlocks or trying to isolate small sequences from other plasmids or PCR products, which is difficult when the DNA is less than 100 bp.

- *Multiplex Assembly*

Using traditional cloning techniques, there is the possibility of assembling several inserts at once into a backbone. Although other techniques like biobrick assembly allow simultaneous inclusion of two inserts and Gibson assembly can put together more than two but requires design of large homologous regions, traditional cloning has been known to construct plasmids from three or more inserts. The unique sticky ends that can be constructed on the 5' and 3' end of each DNA sequence and the vector permits a theoretically unlimited number of fragments that can be ligated together due to the fact that there is only one unique orientation in which they will form a complete plasmid. This is a convenient way of putting together several sequences at once especially when coupled with an RFC protocol that expands the number of isocaudomers.

## Additional information

DoubleDigest calculator by Thermo-Scientific - Thermo Scientific: If one is using two different restriction enzymes, you have to make sure to use an optimal buffer for both enzymes. The Double Digest Calculator allows you to quickly find the right buffer.



Enzyme Finder by New England Biolabs - This tool gives you a nice overview of all commercially available restriction enzymes as well as their recognition sequences and other properties of interest.

ApE: ApE is a nice freeware plasmid editor, that allows you to display your plasmid with its restriction sites, do in silico cloning or simulate agarose-gels after certain restriction digests.



# iGEM Manchester-Graz

## Why traditional cloning?

Standard molecular cloning is the main technique often used by iGEM teams. It has the ability to transfer genes from almost any organism into a host, such as *E. coli*. Manchester chose this tried-and-tested method as our project is relatively simple in its requirements for recombinant gene expression.

Furthermore, here at the Manchester Institute of Biotechnology we already have much of the equipment required for traditional cloning, enabling us to insert plasmids and grow up *E. coli* to a large volume both cheaply and efficiently.

## Materials

- Vector NTI® by Life Technologies to design our constructs
- SnapGene® to design subcloning PCR primers
- gBlocks® and custom oligos by Integrated DNA Technologies®
- pTrcHis2 by Invitrogen®
- pCDF-1b by Novagen®
- NcoI, AvrII and HindIII restriction enzymes by NEB®
- T4 ligase by NEB®

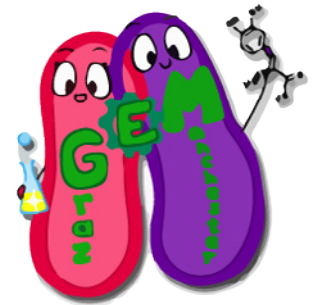

## Design considerations

1. You need to know the restriction enzyme sites (RE) available for sub-cloning in the parent vector multiple cloning site (MCS) and the destination vector MCS. RE sites in the parent MCS should either be common with or compatible with destination MCSs. The RE site should also not be within the target gene.
2. Double digests are performed on parent and destination vectors. If a common buffer is used, make sure to use a buffer where enzyme activity is at least 75%. If the two enzymes are not compatible, either sequential digests, longer incubation in buffer or addition of more enzyme can be carried out.
3. Destination vector is dephosphorylated to prevent self-ligation by removal of 5' phosphates of linearized vector. Calf intestinal alkaline phosphatase (CIAP) is most commonly used for dephosphorylation and can be used for REs that produce 3' overhangs, 5' overhangs and blunt ends. CIAP is removed via gel electrophoresis, direct purification, or gel isolation using DNA purification systems. Shrimp alkaline phosphatase is an alternative and can be heat denatured, removing the need for purification.
4. Gel purification can be performed to remove uncut or partially-cut destination vectors.
5. Negative controls with self-ligated vectors can indicate the proportion of uncut or self-ligating vectors in the final sample. Control for ligation reaction can be set up. It would contain all components of ligation mix except the gene. Both the control with empty vector and the vector with ligated insert are transformed into suitable bacteria. If colonies are only present in the vector with gene insert, it means empty vector did not self-ligate.

## Experiences

- *How did you experience working with this cloning method?*  
It is quite laborious compared to the newest cloning strategies, however traditional cloning provides a cheap and rather easy way of cloning.
- *What was the most difficult task?*  
Finding the right conditions and buffers to perform a double digest can sometimes be a little tricky, although this is much simplified using the double digest finder by NEB.
- *Did the cloning method work as expected?*  
Yes, usually everything worked with a high efficiency. Still, every cloning step was followed by control restriction digests, to verify correct cloning and sort out clones with plasmids without insert.
- *What was the biggest achievement using this cloning method?*  
Successful cloning of insert into target vector.
- *What would be your tips and tricks if other teams are going to use this method?*  
Standard cloning is more or less foolproof as long as you stick to the protocol you can hardly do anything wrong. We would recommend this method if you want a simple method to implement your pathway/constructs and extra time to focus on other experimental or outside the lab aspects of your project.

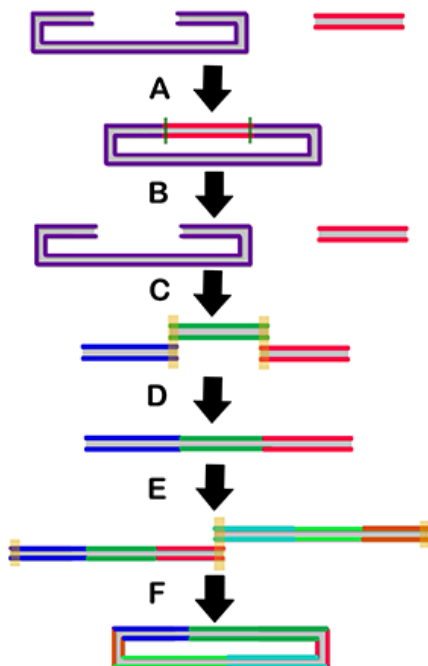

Figure 4 - iGEM Manchester-Graz's vector assembly strategy featured a combination of Gibson Assembly & Traditional Cloning.

## Protocols

A direct link to the protocols of the Manchester-Graz team. The protocols include digestion, ligation and amplification steps, which the team has performed with this specific cloning method.



## iGEM Manchester-Graz

Our team consists of six students from the University of Manchester and six students from the Graz University of Technology. Being an inter-European team has given us the chance to develop a project with two interlinking parts: We are developing a novel drug delivery system for L-DOPA and dopamine alongside a multi-dimensional regulation system for protein expression with the future potential for implementation as a self-regulated one-course treatment for Parkinson's disease.



Figure 5 - Team photo of the inter-European GEM Manchester-Graz. Rachel Stirrup, Magdalena Kurteu, Maria Imran, Priyanshu Sinha, Aaron Gretton, Iaroslav Kosov, Christoph Schilling, Markus Hobisch, Martin Senekowitsch, Peter Kusstatscher, Kerstin Stadler, Maria Hulla, Melanie Ballach

# iGEM Vanderbilt

## Why traditional cloning?

This cloning method allows a lot of flexibility; there are no illegal restriction sites that have to be avoided since any restriction enzyme that has a recognition site in the sequence can be used. Furthermore, it has a very straightforward methodology of cutting and pasting. Lastly, in terms of design and reagents it is one of the cheapest assembly methods.

## Materials

- Restriction Enzymes (Fermentas®, NEB®)
- Reaction Buffer (often supplied with the enzymes)
- gBlock (IDT®), PCR product, annealed oligos (IDT®), digested DNA
- Plasmid backbone (available from Addgene®, IDT®, NEB®)
  - Some of the more common ones are the pUC and pET series which are well documented and easy to use for beginners.
  - Multiple cloning sites (MCS) variants can be used as a plasmid backbone.

To help with cloning in terms of finding restriction sites as well as visualizing the components and end product, software is often helpful:

- A Plasmid Editor (ApE)
- Genome Compiler gives free access to iGEM teams and has advanced features although it is difficult to use for beginners.

## Design considerations

1. Choose a vector appropriate for the project you are working on (make sure the origin of replication is right for your model organism, the antibiotic or auxotrophic marker is correct, and that the appropriate tags, promoters, and terminators are in place).
2. Decide which enzyme(s) you wish to cut the vector and insert. If you are using annealed oligos, determine what overhang complements the vector's cut sites:
  - a. Single enzyme sticky – lack of specificity since the insert can attach itself in either orientation
  - b. Single enzyme blunt – lack of orientation specificity and low ligation efficiency.
  - c. Double enzyme sticky – high specificity and ligation efficiency
  - d. Double enzyme blunt – high specificity but low ligation efficiency
3. Make sure the enzymes you are using have the proper locations and number of cut sites and that you are not using two isoschizomers (same recognition site) or isocaudomers (same cleavage product).
4. Check the methylation sensitivities of the enzymes you want to use (dam, dcm, CpG) and ascertain if the plasmid you are cutting comes from a dam+/dcm+ or dam-/dcm- strain.
5. When annealing oligos for your insert, make sure to include the correct overhangs to correspond to the sticky sites on the plasmid since digesting annealed oligos is inefficient due to their lack of overhang and low purify yield.
6. If you are ordering the DNA insert as a gBlock and the sequence has an improper restriction site, use synonymous mutation to remove the recognition sequence.

## Experiences

- *How did you experience working with this cloning method?*  
This method is unique in the fact that there are so many variables to consider: blunt-end enzymes cut under different conditions than sticky-end enzymes. One has to keep track of the right digestion buffer to use for each enzyme as well as its period of effectiveness before star-activity. This can be done by looking whether an enzyme can be heat inactivated, at what temperature, and for how long it has to be inactivated. In addition to the digestion, the ligation can vary in times and temperatures depending on the size of the fragment and the type of overhang. Traditional cloning works well when each parameter is optimized for the enzymes and sequences being used.
- *What was the most difficult task?*  
The most difficult task is determining the proper enzymes to use. Their restriction sites need to be at the right position, there needs to be enough space adjacent to them for the enzyme to cut, and many other factors described above need to be taken into consideration.
- *Did the cloning method work as expected?*  
We have had great success using this cloning method. However, even experienced labs will occasionally have difficulties using this technique. Despite this, when optimized, this method of cloning should have a success rate of well above 90%.
- *What was the biggest achievement using this cloning method?*  
We were able to take pUC19, a common plasmid, and turn it into a yeast genomic integration vector that also has bacterial expression. This was done by integration of two gBlocks using BamHI, ClaI, and KpnI sites. Then the plasmid was made biobrick compatible by the excision of illegal sites and replacement with short dsDNA formed by annealing oligos, which is faster and cheaper than using site-directed mutagenesis.
- *What would be your tips and tricks if other teams are going to use this method?*  
Spend time to optimize your protocol. Many labs simply follow whatever protocol has been passed down over the years, without searching for themselves if there are better ways these protocols can be done. Investing the time to try other protocols, make tweaks to each step, and find out what works best, can pay off in the long term.



## iGEM Vanderbilt

We are the iGEM team from Vanderbilt University in Nashville, TN. The group is made up of about 8 undergraduates majoring in sciences ranging from biology to math. This year's project is the modulation of evolutionary potential where we take DNA sequences and optimize them to reduce the possibility of mutation. We then apply other principles of genetic stability to gene circuits and entire organisms. To this end, we have written an algorithm that incorporates decades of DNA damage research to generate the best possible sequence. Our research has substantial implications in the field of biosafety, commercial biomanufacturing, and DNA therapeutics.

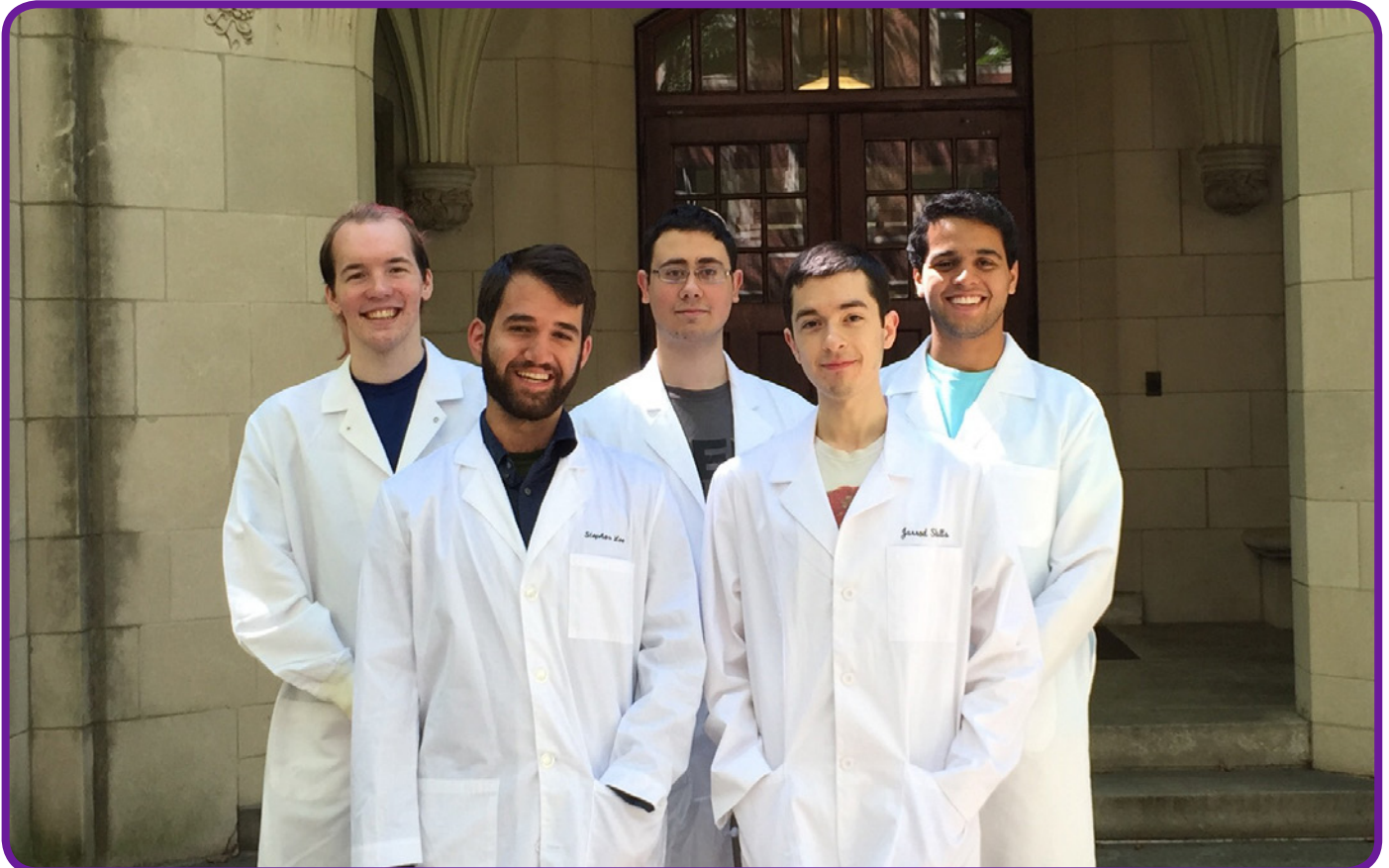

Figure 6- Team photo of iGEM Vanderbilt. Photograph (Left to Right): Daniel McClanahan, Stephen Lee, Ophir Ospovat, Jarrod Shilts, Sikandar Raza

## Protocols

Protocols describing the various cloning steps performed by the iGEM team Vanderbilt. These protocols include important digestion, ligation and purification steps.



# Carnegie Mellon iGEM

## Why traditional cloning?

We chose this method because of the hundreds available enzymes, each with a specific target sequence, which gives us a predictable resulting end. In addition, it is relatively cheap therefore it is very efficient to use this method given our budget.

## Materials

- Restriction Enzymes (NEB®)
- Reaction Buffer (often supplied with enzymes)
- gBlock (IDT®), PCR product, annealed oligos (IDT®), digested DNA
- Plasmid backbone (ADDgene®, IDT®, NEB®)
  - Common plasmid backbones are part of the pUC and pET series which are easy to use for beginners.
- To assist with cloning in terms of finding restriction sites, we often use software:
  - A plasmid editor (ApE) is used to sequence the DNA and is easy to use.
  - Genome compiler gives access to iGEM teams and advanced features but it is hard to understand for beginner applicants.

## Experiences

- *How did you experience working with this cloning method?*

It worked really well. We did not have much trouble when going through our method, but there were some struggles especially when it came to obtaining the fluorescence wanted from the plasmids used. We had a difficult time transforming the correct plasmid into the chassis, but it was pretty simple isolating the correct plasmid.
- *What was the most difficult task?*

The most difficult task was transforming the correct plasmid into the chassis. We would isolate the correct plasmid but then transforming the plasmid into the chassis required us to do a lot of troubleshooting and going through our protocol over and over making sure we did everything correctly.
- *Did the cloning method work as expected?*

The cloning method did work as expected. We did obtain the fluorescence for a few of the organisms we used. We unfortunately could not obtain it for the PelB Gaussia due to the inconsistencies. The inserts were excreted out of the inconsistent cells which made transformation difficult. Since transformation likelihood was low, the fluorescence being seen was also very low.
- *What was the biggest achievement using this cloning method?*

The biggest achievement was extracting and isolating the fluorescence from most of the organisms we used such as the firefly, which we could use for our fluorimeter.
- *What would be your tips and tricks if other teams are going to use this method?*

Some tips and tricks for other teams would be to make sure the plasmid is isolated correctly with few inconsistencies in the DNA sequence to make sure transformation is possible. For a few of our plasmids, since we had a few changed sequences, the transformations failed sometimes which is why we had to redo some of it.

## Design Considerations

Preparation of vector and insert

Insert from a PCR product:

1. Design primers with appropriate restriction sites to clone unidirectionally into a vector. Choose proofreading polymerases such as Phusion High-Fidelity (HF) DNA Polymerase.
2. Use Phusion PCR to optimize plasmid and amplify DNA.
3. Purify the vector and insert using the PCR purification kit. Then follow the QIAquick PCR purification Kit Protocol.
4. Using appropriate restriction enzymes, cut the appropriate sites
5. Cut out the samples in obtaining the DNA and repeat the PCR purification kit protocol in order to isolate the correct plasmid being analyzed.

## iGEM Carnegie Mellon

This is the Carnegie Mellon University iGEM team, which consists of ten undergraduate students. There are five biologists and five engineers on the team ranging from majors of Electrical & Computer Engineering to Biology. We work at Mellon Institute and do collaborations with University of Pittsburgh, Georgia, and Eindhoven.



Figure 7- Team CMU Left to Right. Top: Kenneth Li, Jordan Tick, Will Casazza, Max Telmer, Nitesh Sundaram. Bottom: Wei Mon Lu, Dominique Cheylise, Ruchi Asthana, Donna Lee, Michelle Yu

## Protocols

- The protocols used were adapted from New England Biolabs ' Traditional Cloning Quick Guide



## References:

- [1] Roberts RJ (2005) "How restriction enzymes became the workhorses of molecular biology"; Proceedings of the National Academy of Sciences of the United States of America 102 (17): 5905-8
- [2] [https://www.embl.de/pepcore/pepcore\\_services/cloning/cloning\\_methods/restriction\\_enzymes/](https://www.embl.de/pepcore/pepcore_services/cloning/cloning_methods/restriction_enzymes/)
- [3] <https://www.neb.com/tools-and-resources/usage-guidelines/cloning-guide>

# 3A Assembly

## Introduction

The story of 3A assembly is tied up with the story of BioBricks themselves. All BioBricks contain a prefix and a suffix, standardized sequences of DNA about 20 base pairs long that can be cut by specific restriction enzymes [1]. This feature is what allows BioBricks to be easily combined with one another.

While the aptly named “traditional assembly” remains the most fundamental method of cloning BioBricks, 3A assembly offers a useful alternative. 3A stands for “3 antibiotic,” which refers to the different antibiotic present in the backbones of each of the parts to be combined. Although 3A assembly cannot be used in as many cases as standard assembly (for example, it will not work if you wish for your final construct to have the same antibiotic resistance as its component parts), 3A assembly offers some distinct advantages over standard assembly. For example, it has a higher success rate, and its products do not need to be gel purified [2]. In contrast to standard assembly, in which one part is cut from its backbone and ligated into the backbone of another part, 3A assembly involves cutting both parts from their vectors and ligating them with a linearized backbone. However, as figure 8 shows, 3A assembly follows the same principle of cutting the BioBrick prefix and suffix with restriction enzymes, then ligating them to produce a scar that can no longer be cut.

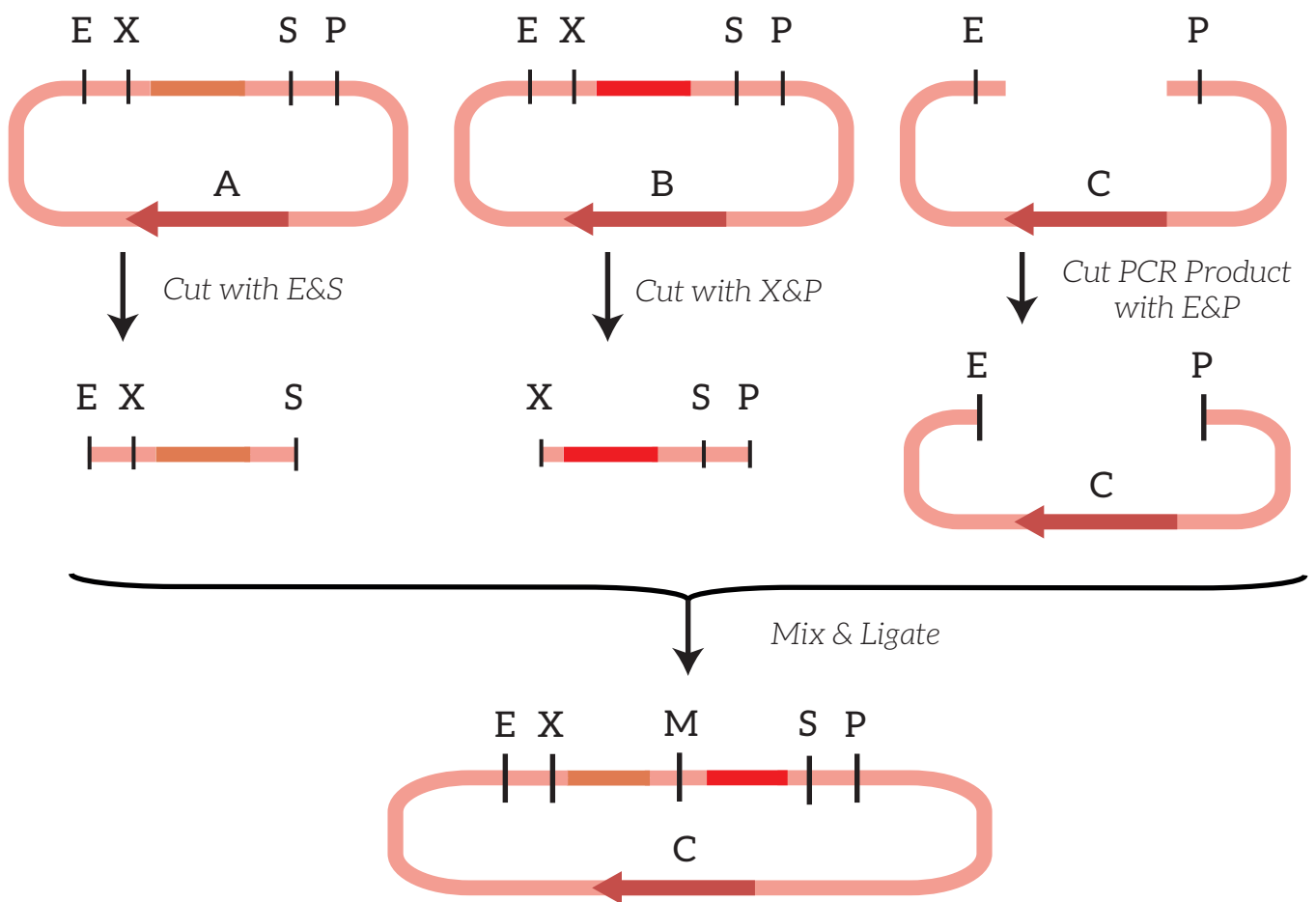

Figure 8- A diagram showing the digestion scheme used for 3A assembly. When the two parts you wish to combine (A and B in the figure) are digested with the appropriate enzymes, they can be ligated to create a scar that is no longer recognizable by the enzymes. When cells containing the construct are plated on the same antibiotic which the backbone (C in the figure) confers resistance to, most of the surviving colonies will contain the parts cloned into the vector [3]. This image was adapted from iGEM.

## Points of interests

- The parts being used must have a BioBrick prefix and suffix.
- The part inserts must have different antibiotic resistance from the backbone; otherwise, there is no way of selecting for the correct construct.
- It is sometimes possible for a “parent” part plasmid to be transformed into the clone along with the desired construct. If you suspect this has happened, it’s advisable to screen the clone for resistance to the parent’s antibiotic [5].

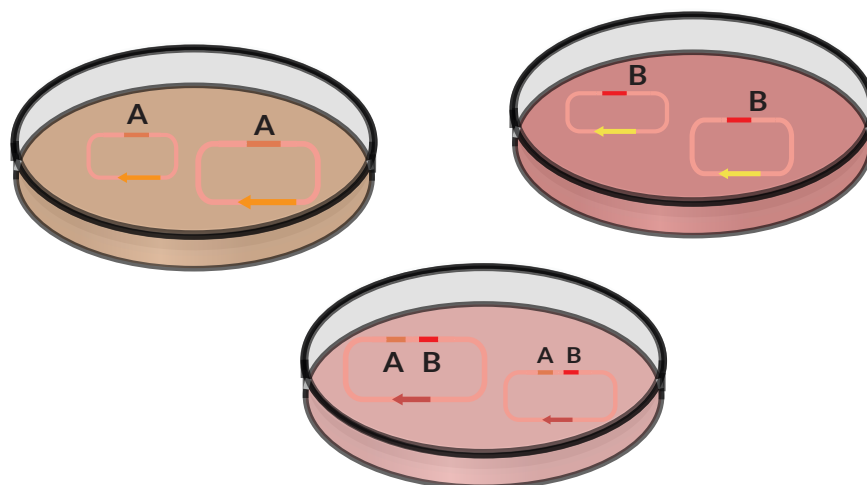

Figure 9- Culture plates showing the process of 3A assembly. Parts are separated from colonies with a different antibiotic resistance marker than the marker present in the destination vector, enabling insertion of two fragments within a single reaction.

## Advantages

- Gel purification of the digested parts is not necessary for good results.
- Saves time when up-scaling.
- When done correctly, 97% of colonies will have the desired assembly [2].
- Works even with small pieces of DNA
- It’s very “iGEM-friendly,” since iGEM already provides the required linearized backbones.

## Disadvantages

- If the parts do not already come in the correct vectors, cloning them into the proper backbone eliminates much of the speed and convenience of 3A Assembly.
- Yields a lower concentration of DNA than standard assembly, because three pieces are ligated rather than two.

## Further applications

- *Changing the resistance marker*  
This method can be useful if you wish to transfer parts into backbones with alternative antibiotic resistance; for example, if you wish to move parts from backbones providing ampicillin resistance to those providing chloramphenicol resistance.
- *Assembling DNA from PCR*  
A modified version of 3A assembly can also be used if amplifying DNA in two halves using PCR. After purification, you can treat the two amplified DNA fragments as digestions from BioBricks, if you include the BioBrick prefix and suffix in the primers. Then, you can assemble them directly into a BioBrick plasmid backbone using the same protocol as 3A assembly.

## Frequently Asked Questions

- *What does 3A stand for?*  
It stands for “3 Antibiotic,” after the 3 antibiotic markers found in the backbones of your construct.
- *Is it necessary to have three antibiotic markers? Can't I just use two instead (each insert has antibiotic A, while the backbone has antibiotic B)?*  
We think this would work perfectly fine. The only disadvantage would be that it's more difficult to tell your inserts apart if you are troubleshooting later on.
- *I'm assembling two BioBricks together. Should I use 3A Assembly or traditional cloning?*  
This really depends on what parts you're using. Many iGEM parts are in backbones with chloramphenicol resistance, such as PSB1C3. If you want to put together two parts from PSB1C3, and have the assembled product still have a PSB1C3 backbone, then you'll probably want to use traditional assembly. However, if you have different backbones for your component parts and your desired construct, then you may find that 3A Assembly is quicker and easier than the alternatives.
- *Is it necessary to test the assembled construct for accuracy?*  
In theory, only the correct constructs should remain once you grow your constructs on the appropriate antibiotic. However, a quick double digest and diagnostic gel is always a good step to take to confirm that your construct is the correct one.

## Useful additional information & resources

iGEM Academy has published a video which walks you through the process of performing a BioBrick 3A Assembly. The video includes the protocols for digestion & ligation.



If you are interested in a recent paper discussing the advantages of different assembly techniques in synthetic biology we suggest from the Imperial College of London titled *Developments in the Tools and Methodologies of Synthetic Biology* (authors include Richard Kelwick, James MacDonald, Alexander Webb, and Paul Freemont).

# UIUC iGEM

## Why 3A Assembly?

Our team's project involves incorporating an analog biosensor (one that can detect an input across a spectrum) with genetic memory. Part of our testing involved comparing the output of our device with traditional biosensor constructs consisting of a promoter plus a GFP reporter.

To assemble these constructs, we plan to use a combination of traditional assembly and 3A assembly, deciding on a case-by-case basis which is easier for the particular construct we have in mind. We chose these methods because all of the parts required for our GFP constructs are already in BioBrick form, making BioBrick-specific cloning methods the natural choice.

## Materials

- DNA Purification Kit (We used Omega Bio-Tek®)
- Restriction enzymes (We used EcoRI-HF, XbaI, SpeI, PstI from New England Biolabs®)
- NEBuffer, such as CutSmart(NEB®)
- 10X T4 DNA Ligase reaction buffer, T4 DNA Ligase
- H<sub>2</sub>O
- Destination plasmid as purified DNA
- Upstream and downstream parts as purified DNA

## Design considerations

iGEM provides a very useful protocol in the "help" section of the Registry of Standard Biological Parts. Our team follows this protocol, but has also noted a handful of changes.

The protocol states to digest the parts for 30 minutes, but our team typically increased this time to 1-2 hours before proceeding to heat killing, or even up to 4 hours if the schedule permitted. We also used a larger amount of restriction enzymes-- typically 0.8 - 1.0  $\mu$ L of each enzyme per tube. These changes were made to ensure that as much of our DNA as possible was properly digested.

Also, Open WetWare notes that 3A Assembly can sometimes fail due to genomic DNA being cloned into the construction plasmid, and advises phosphatase treatment of the linear plasmid construct as a remedy[5].

## Protocols



OpenWetWare has a page dedicated to 3A Assembly. The page contains some explanatory graphs, good protocols & troubleshooting tricks and should be a good starting point for beginning iGEM teams.

iGEM Illinois has compiled the used protocols on their iGEM Wiki. Take a look at their wiki to find an overview of these protocols.



3A Assembly plays a central role within the iGEM competition, as the iGEM foundation provides participating teams with BioBricks following the 3A Assembly standard.

To get teams started, iGEM has published some protocols on their website.

## Experiences

- *How did you experience working with this cloning method?*  
Due to time restrictions, we ended up using our cloning method only once (not counting a “practice run” in our training sessions at the beginning of our competition season). We find 3A Assembly to be very user-friendly, with relatively few problems arising.
- *What was the most difficult task?*  
The most difficult task was the planning stage. When we realized that the two parts we wanted to assemble were both in chloramphenicol backbones, we had to be flexible and look for alternate plasmids. As iGEM moves more toward making sSB1C3 the standard backbone, it actually becomes harder to mix and match the antibiotic resistance markers and design constructs for 3A Assembly.
- *Did the cloning method work as expected?*  
Yes, we got results on our first try!
- *What was the biggest achievement using this cloning method?*  
We were able to assemble an IPTG sensor by combining a lac promoter with a ribosome binding site - yellow chromoprotein - terminator cassette. Due to delays in other areas of our project, we were unable to characterize our construct, but the 3A Assembly went very smoothly.
- *What would be your tips and tricks if other teams are going to use this method?*  
If time allows, we often give an extra hour or so for digestion and ligation in addition to what the protocol recommends.



## UIUC iGEM

Hi, we're team UIUC\_Illinois! Our team consists of 10 undergraduates in addition to several advisors. This year, we focused on making the SCRIBE system, designed by members of the Timothy Lu lab at the Massachusetts Institute of Technology (MIT), into a characterized, Bio-Brick-compatible part. Also called the "genetic tape recorder," the SCRIBE system uses genomic recombination events to measure the frequency, intensity, or duration of the inducer that the chassis organism encountered. This represents an advantage over traditional biosensors, which can generally say whether an inducer was encountered but cannot indicate how much or how long.



Figure 10- Team Photo of UIUC iGEM. From the left: Jess Beaudoin (advisor), Linyang "Andrew" Ju, Joshua Cheng, Caroline Blassick, Dr Yong-Su Jin (advisor), Miranda Dawson, Ashwin Pillai, Noah Flynn, Michelle Goettge (advisor), Erik Anderson (advisor), James Blondin, Todd Freestone (advisor), Pierce Hadley, Zach Costliow (advisor), Sameer Andani, Aru Singh

### References:

- [1] T. F. Knight, "Idempotent Vector Design for Standard Assembly of BioBricks - MIT Synthetic Biology Working Group Technical Report." [Online]. Available: <http://web.mit.edu/synbio/release/docs/biobricks.pdf>. [Accessed: 27-Jul-2015].
- [2] "Help:Protocols/3A Assembly (iGEM Registry of Standard Biological Parts)." [Online]. Available: [http://parts.igem.org/Help:Protocols/3A\\_Assembly](http://parts.igem.org/Help:Protocols/3A_Assembly). [Accessed: 27-Jul-2015].
- [3] R. P. Shetty, D. Endy and T. F. Knight, "Engineering BioBrick vectors from BioBrick parts," J. Biol. Eng., vol. 2, no. 1, p. 5, Jan. 2008.
- [4] B. Canton, A. Labno and D. Endy, "Refinement and standardization of synthetic biological parts and devices," Nat. Biotechnol., vol. 26, no. 7, pp. 787-93, Jul. 2008.
- [5] "Synthetic Biology:BioBricks/3A assembly - OpenWetWare." [Online]. Available: [http://openwetware.org/wiki/Synthetic\\_Biology:BioBricks/3A\\_assembly](http://openwetware.org/wiki/Synthetic_Biology:BioBricks/3A_assembly). [Accessed: 27-Jul-2015].

# Gibson Assembly

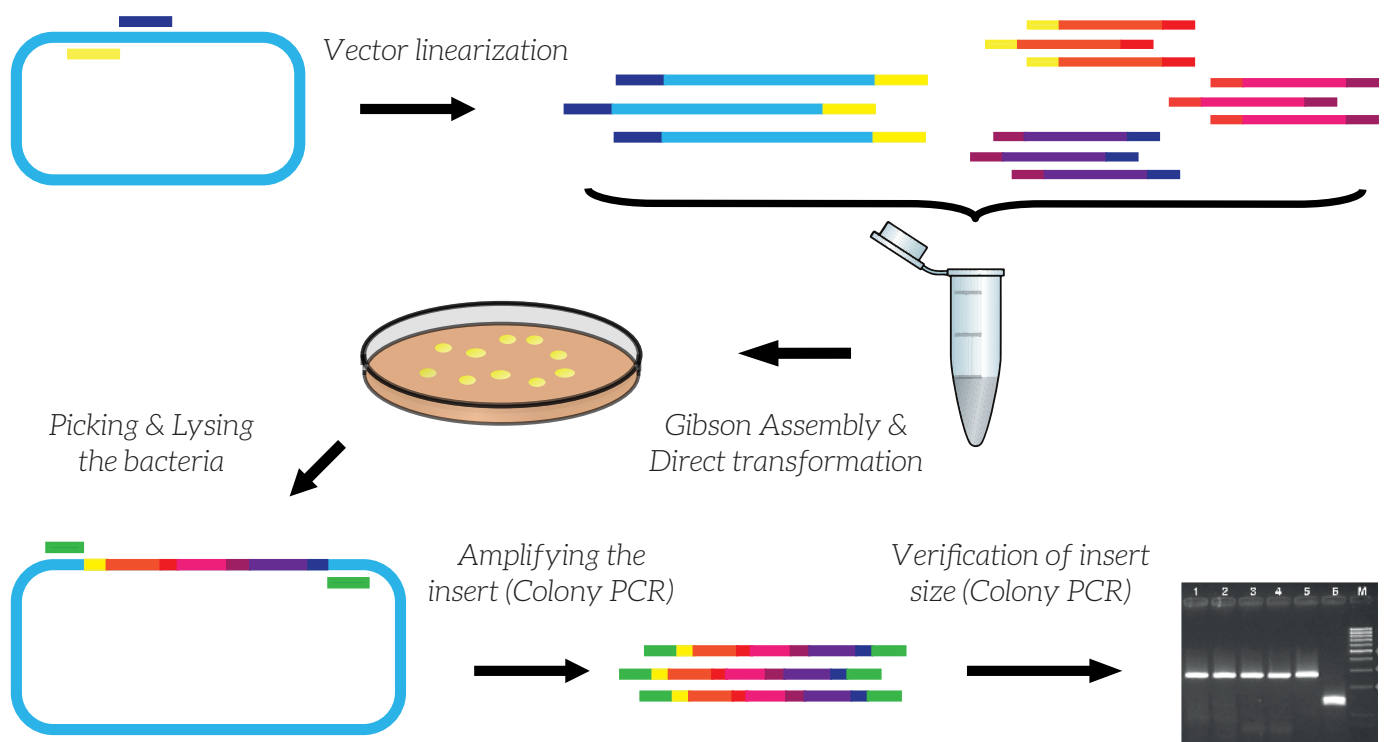

Figure 11 - General workflow of Gibson Assembly. The first step consists of linearizing the vector using either PCR or digestion by restriction enzymes. Next, the linearized vector and dsDNA fragments are introduced in a tube with the Gibson Assembly Master Mix, and incubated at 50°C. The resulting mixture is transformed into competent cells and analyzed using colony PCR to select the correctly assembled vectors.

## Introduction

Back in 2004, Daniel Gibson and his team undertook the effort to assemble an entire bacteria genome from scratch (the *Mycoplasma genitalium* genome). This posed a monumental challenge, since the genome was far too complex to be assembled by sequential restriction enzyme mediated cloning, known as traditional cloning [1]. To assemble the genome more efficiently, he started with a two-stage approach involving three enzymes, a 3'-5' exonuclease, a Taq DNA Polymerase and Taq Ligase. The first step involved a 3'-5' exonuclease which initially "nibbled" back the ends of the complementary ends of the DNA fragments which needed to be inserted in the vector. After a short incubation, the reaction was heat inactivated and then cooled to anneal the newly exposed complementary ends. The second step features the polymerase and ligase, which respectively fill the gaps between the newly annealed complementary ends and seal the nicks, producing a single, continuous DNA strand.

The key to success of the Gibson Assembly method appeared to be ligation, which enabled Gibson and his team to build larger DNA fragments, and even an entire genome. Although they reached their primary goal, some tweaking on the Gibson Assembly method was needed. The biggest problem during the development of his new technique was the chew-back step, since the 3'-5' exonuclease and the DNA Polymerase competed for the 5'-overhangs. This problem was eventually overcome by Gibson by swapping the T4 Polymerase for a T5 Exonuclease, which digests DNA from the 5'- to the 3'-end [2].

This change enabled Gibson Assembly to become a very efficient method: nowadays, up to six dsDNA fragments can be assembled within a single Gibson Assembly reaction.

## Points of interests

- Gibson Assembly requires linearized vectors and dsDNA fragments.
- The vector can either be linearized by restriction digestion or PCR. Gibson himself used PCR in his revolutionary paper which was published in *Science* [1].
- The dsDNA fragments need to have complementary overhangs with adjacent fragments. This is needed to anneal the fragments in the right order during the Gibson Assembly.
- The dsDNA fragments can be directly ordered at a supplier or generated by PCR.
- The overlaps should be clear of secondary structures and range from 15-80 basepairs.
- The overlaps should be unique. This makes Gibson Assembly difficult albeit not impossible for repetitive sequences.

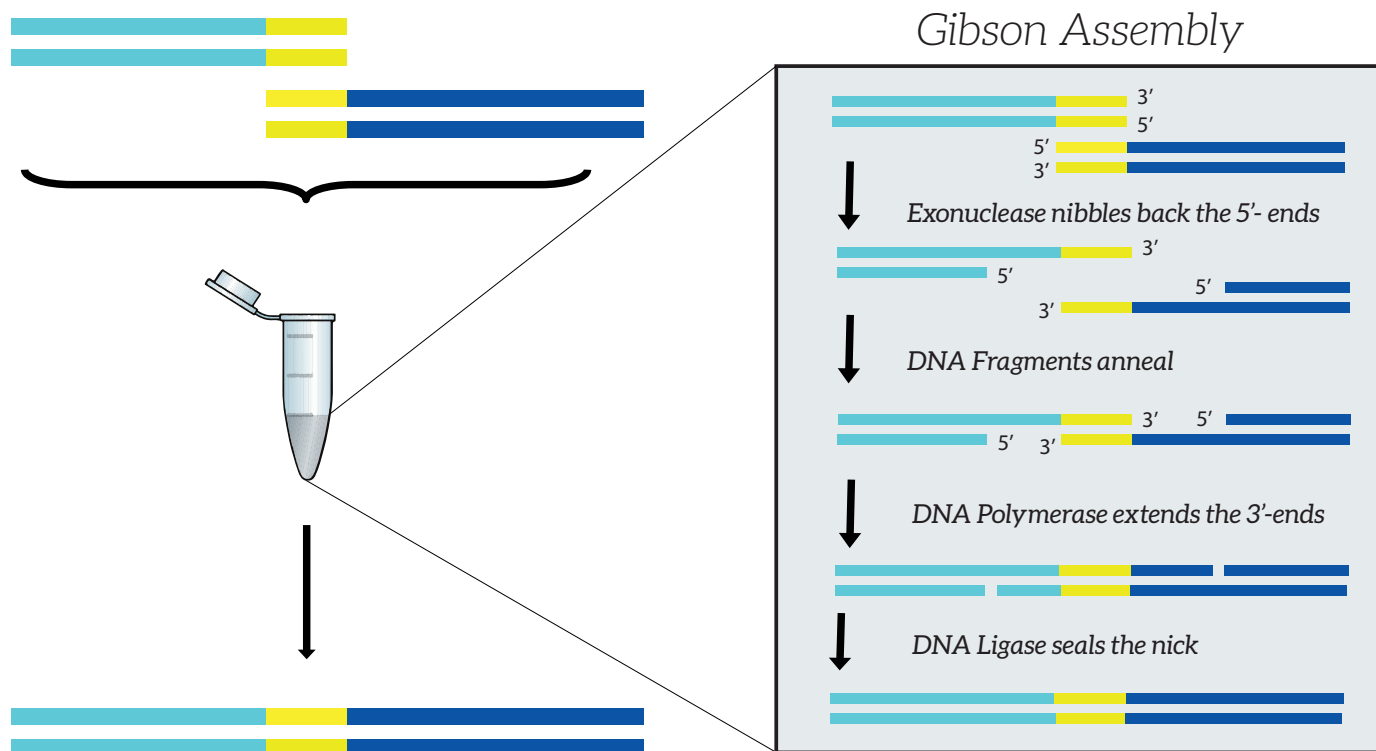

Figure 12 - Overview of the one-tube assembly reaction. First, the exonuclease activity nibbles back the 5'-ends of the dsDNA fragments. Second, the DNA fragments anneal due to the newly exposed complementary ends. Third, the DNA Polymerase extends the chewed back 3'-ends. Finally, the DNA Ligase seals the nick, yielding a continuous DNA plasmid. This image was adapted from NEB®.

## Advantages

- Gibson Assembly is a method which enables directional cloning.
- Gibson Assembly is very rapid and efficient: multiple fragments can be combined in a single-tube reaction.
- Possibility to assemble large gene fragments and generation of gene libraries.
- Gibson Assembly is a seamless method. It does not yield any scars, which cloning methods that rely on restriction enzymes do have.

## Disadvantages

- Gibson Assembly requires meticulous design of your experiments.
- Gibson Assembly is very difficult to troubleshoot. If your assembly does not work, you'd better have a back-up plan at hand.
- Gibson Assembly fragments are virtually non-interchangeable: the fragment overlaps are very specific, causing trouble when parts need to be switched out.

## Further applications of Gibson Assembly

- *Site-Directed Mutagenesis (see Figure 13)*

Gibson Assembly can be used to make rapid changes to DNA fragments, including substitutions, deletions and insertions (see Figure 13). To use Gibson Assembly for mutagenesis, the desired changes are introduced into primers such that fragments are generated carrying the mutations in their overlapping sequences. To modify a DNA sequence in this way, two primers are required per mutation, both carrying the desired nucleotide changes. Following the amplification with the mutated primers, the fragments can be assembled into the final product.

- *Assembly of large DNA constructs*

Worldwide laboratories are beginning to explore the use of synthetic biology in the production of pharmaceuticals, industrial compounds antibiotics, cosmetics and alternative energy sources. This often requires the assembly of a genetic pathway consisting of multiple enzymes and their associated regulatory elements. Although template DNA is still required, Gibson Assembly simplifies construction of the DNA coding for these types of molecules. A long stretch of desirable DNA sequences can be broken down into several overlapping PCR products, which can then be amplified by conventional PCR and combined using Gibson Assembly.

- *Assembly of chemically-synthesized oligonucleotides into dsDNA fragments*

Gibson Assembly can be used to directly assemble oligonucleotides into a cloning vector. A common problem observed when chemically synthesizing long stretches of oligonucleotides, is the introduction of errors. To ensure that error-free molecules are obtained at a reasonable efficiency, a strategy employed by SGI and JVICI involves the assembly of only eight to twelve 60-base oligonucleotides (with 30 bp overlaps) at one time. The resulting dsDNA is sequence-verified and assembled into larger DNA fragments using the same approach. Because assembly itself does not generally introduce new errors, the final assembled product can be retrieved at high efficiencies. Using this approach, many of the costly and time consuming steps currently used to synthesize DNA, including PCR and an error correction, are eliminated.

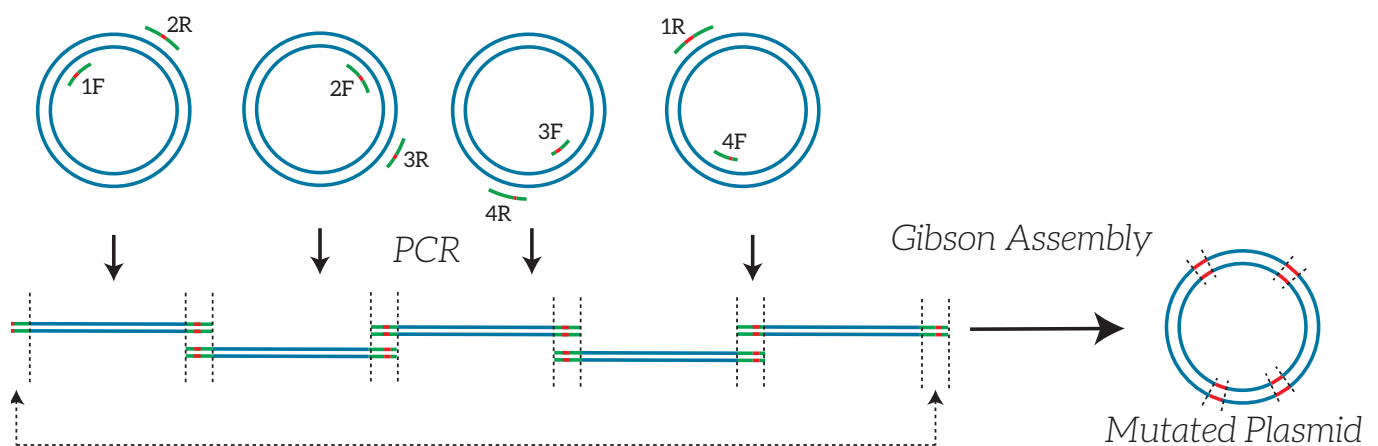

Figure 13 - Multiple mutations can quickly be introduced to plasmids using Gibson Assembly. Through Site-Directed Mutagenesis, modified double-stranded DNA fragments can be generated carrying the mutations within their overlaps. Through Gibson Assembly, these PCR products can be quickly assembled into the final mutated plasmid. This image was adapted from NEB®.

## Frequently Asked Questions

- *How many fragments can be assembled within one Gibson Assembly reaction?*  
Different sources actually cite different numbers of fragments as the number of fragments depends on both the size as well as the sequence of the to be assembled fragments. Gibson Assembly should in all cases, however, provide the correct clone if the number of fragments within a single assembly does not exceed five. If it is necessary to insert more fragments, it might be wise to do two sequential assemblies.
- *Does Gibson Assembly work with repetitive sequences?*  
Yes, Gibson Assembly should work with repetitive sequences. It is, however, important that the overlaps remain unique. If the overlaps do resemble each other, the correct DNA assembly may be produced at a lower efficiency.
- *Is it necessary to digest the template when using PCR to linearize the vector?*  
No, digestion of the template is optional as long as a minimal amount of template vector is used (think 0.5-1.0 ng of template). The template will be transformed into competent cells. If you choose to skip digestion of the template, it is wise to analyze additional colonies using colony PCR to ensure that your DNA fragments have been correctly inserted.
- *What size should my overlaps have?*  
This really depends on the cloning kit you are using. It is best to read out the manual supplied with your cloning kit to find out what overlap size works best. In general, greater overlaps result in a greater transformation efficiency.
- *How reliable is Gibson Assembly?*  
Gibson Assembly is quite a robust and proven cloning technique. However, as the method is homology-based, some fragments are harder to assemble than other fragments. In addition, troubleshooting is quite difficult as the reaction incorporates multiple steps into a single-tube reaction. Hence, many life science firms advise to have a back-up plan should Gibson Assembly fail.

## Useful additional information & resources

Integrated DNA Technologies has published Gibson Assembly Cloning Protocols. This document compiles protocols and instructions for the use of Gibson Assembly in combination with gBlocks™ Gene Fragments.



New England Biolabs provide an instruction manual with its NEBuilder kits. This manual features among others Frequently Asked Questions, Protocols, Usage Notes and Design Considerations.

When you have a dip because your Gibson Assembly failed, it is very easy to get enthusiastic again with the Gibson Assembly song by the Cambridge iGEM Team of 2010.



## Why Gibson Assembly?

In previous years, iGEM TU Eindhoven teams have always used traditional cloning and BioBricking as their assembly standards for cloning. These methods are also frequently used within the labs of our university. We were ready to take on the challenge of introducing our university to a fairly new cloning technique.

Moreover, Integrated DNA Technologies and New England Biolabs offered to sponsor teams with gBlocks® and the NEBuilder® Cloning Kit, enabling us to try dive into Gibson Assembly. It must be noted, however, that we were not prepared to fully bet on Gibson Assembly, both due to the fact that we had never used it before and that it is hard to troubleshoot. As a back-up plan, we devised to use traditional cloning, and for the construction of the vectors which we sent out to iGEM HQ we used BioBricking.

## Materials

For (the design of) our experiments, we used the following materials:

- The pETDuet-1 vector designed by Novagen®.
- The gBlocks® offered by Integrated DNA Technologies.
- The NEBuilder® Cloning Kit, supplied by New England Biolabs®.
- SnapGene®'s, and especially its *in silico* cloning tools (see Figure 14).
- The Q5-High Fidelity Polymerase Master Mix offered by New England Biolabs®.
- GeneRunner to check the overlaps for hairpins and dimers.
- NUPACK® to verify cross-dimers between the different overlaps.
- QGRS Mapper® to generate information on possible G-quadruplexes.

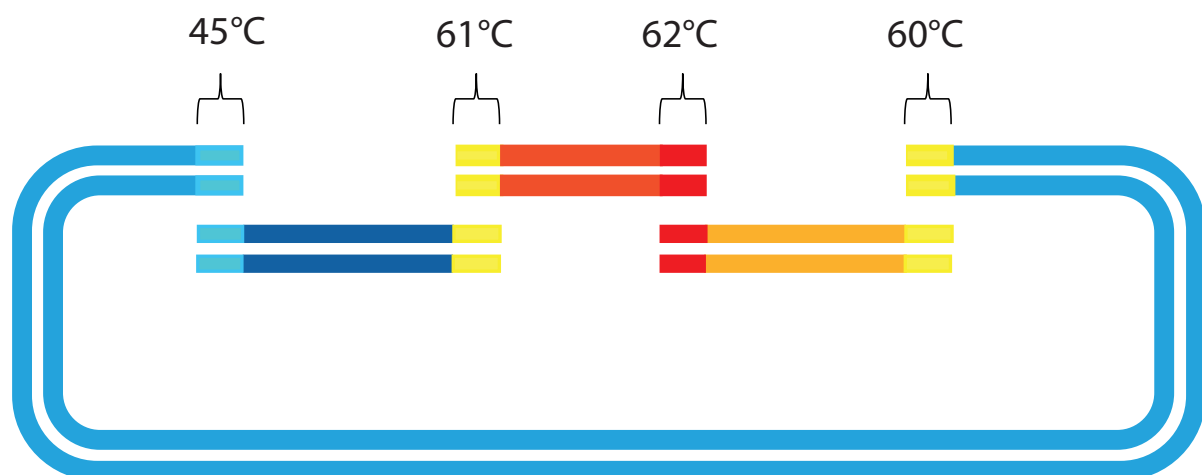

Figure 14 - Melting temperatures of overlapping sequences play an essential role during Gibson Assembly, ensuring specificity and increasing efficiency. Various *in silico* tools exist to simulate the Gibson Assembly and corresponding melting temperatures. This image was adapted from SnapGene®.

## Design Considerations

1. Choose a vector appropriate for the project you are working on.
2. Make a decision on how to linearize the vector prior to the Gibson Assembly reaction. This can be done using restriction enzymes or PCR with appropriate primers. In the latter case, digestion of the PCR template by DpnI can be done to minimize background colonies.
3. Implement all coding sequences that you will use as dsDNA fragments in separate SnapGene® files. These fragments can have a maximum size of 2000 bp.
4. Create a 15-80 bp overhang to all adjacent dsDNA fragments. This differs per protocol, so it is wise to read the manual provided with your kit.
5. Check about 100 bases on each 3' to 5' end of the dsDNA fragments on hairpins, cross dimers and G-quadruplexes. You don't want secondary structures in your overlaps. If necessary, alter the dsDNA fragments using codon optimization.
6. Check all dsDNA fragments on "prohibited" restriction sites PstI, EcoRI, XbaI and SpeI. These are required for BioBricking and thus forbidden to use within the fragments.
7. Check overhangs and the  $T_m$  with the SnapGene®  $T_m$  calculator.
8. Order as gBlocks® or PCR your dsDNA fragments.

## Experiences

- *How did you experience working with this cloning method?*  
We had a few problems starting with Gibson Assembly (our foolishness led to us using the wrong primers for instance). In the end, we became very familiar with the method. The assembly itself is fairly easy and very intuitive.
- *What was the most difficult task?*  
Designing of the gBlocks was the hardest part for our project. Especially the overlapping sequences required a lot of checking and fine tuning. Moreover, we had some setbacks using Gibson Assembly and troubleshooting is also fairly difficult, since many steps are integrated into a single-tube reaction.
- *Did the cloning method work as expected?*  
Yes, the cloning method worked as expected in virtually all assemblies. As mentioned, we had a little trouble starting with Gibson Assembly when we used the wrong primers to linearize the vector. Strangely so, the vector had closed on itself such that we could find colonies on our agar plates. It was not until sequencing when we discovered our mistake.
- *What was the biggest achievement using this cloning method?*  
The biggest achievement was to design gBlocks for the Gibson Assembly which would work as desired, combined with the fact that there are some requirements for the gBlocks. Secondary structure, GC-content and  $T_m$  are some issues to take into account, and when this needs to be done for multiple gBlocks this may be challenging.
- *What would be your tips and tricks if other teams are going to use this method?*  
First of all it is important to get some background on the several cloning methods available nowadays. A guide like this can help, since we know that all the literature available may be overwhelming in the beginning. Second, list all the requirements for your optimal cloning method and compare them with the cloning methods available. All methods do have their advantages and disadvantages, so choose one which suits the needs for your project perfectly. Once you have settled for a cloning method, make sure to read out available literature and especially material from cloning kits supplier. Then entering the lab will become child's play.

## iGEM TU Eindhoven

Our team consists of eleven undergraduate students from Eindhoven University of Technology at the faculty of Biomedical Engineering. This year, we are developing a modular membrane sensor based on click chemistry and aptamers. For our sensor, we sketch a few application scenarios. It can for example be used to diagnose Q fever, used within the intestinal tract and used as a excretor of pesticides.

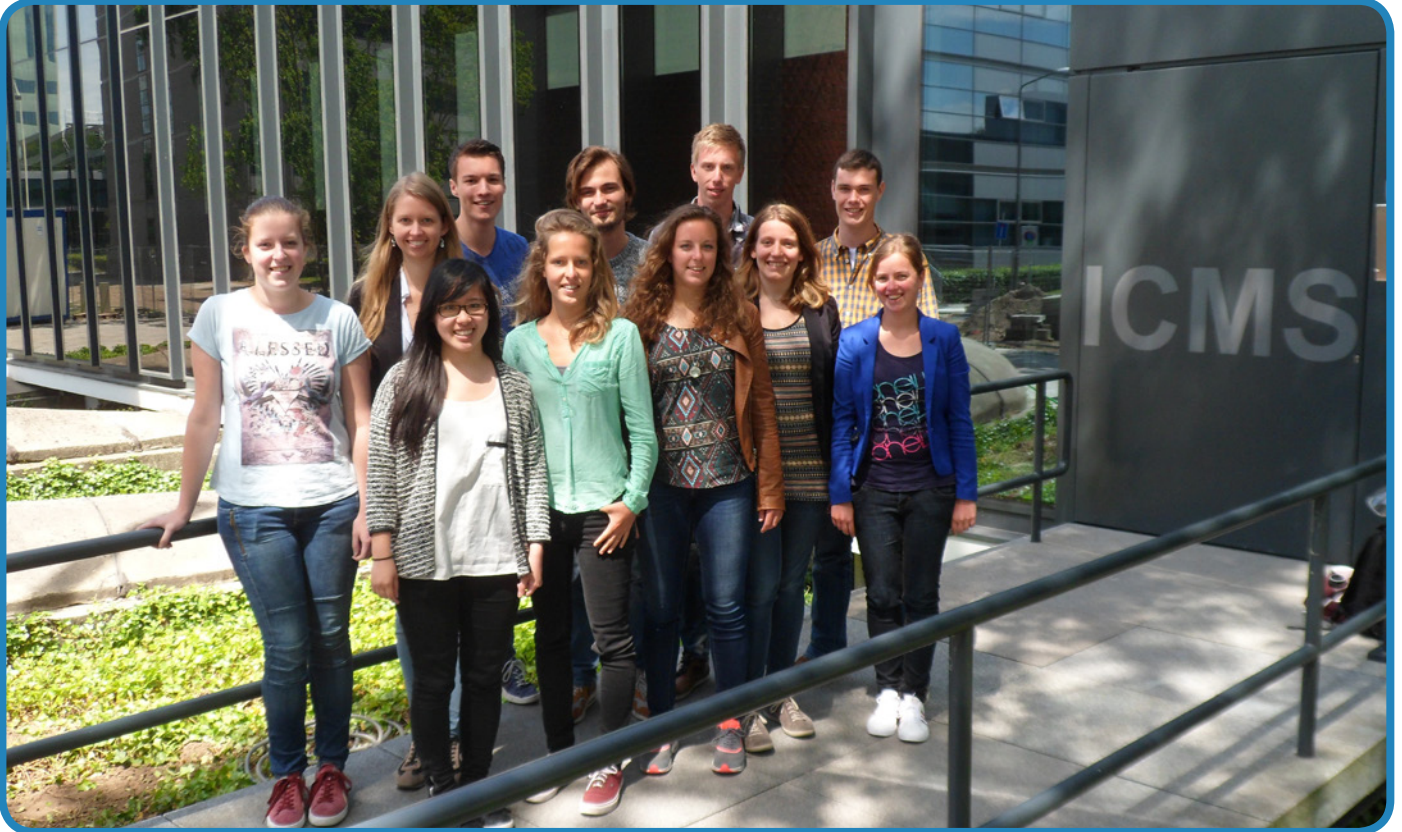

Figure 15 - Team photo of iGEM TU Eindhoven in front of the Institute for Complex Molecular Sciences (ICMS). Top row from left to right; Femke Vaassen, Laura van Smeden, Sjoerd Nooijens, Hans de Ferrante, Cas van der Putten and Jan-Willem Muller. Bottom row from left to right; Kwankwan Zhu, Yeshi de Bruin, Elles Elschot, Laura Jacobs and Esther van Leeuwen.

## Protocols

- **Vector Linearization:** Protocol which can be followed to obtain a linear vector. This protocol consists of a PCR step, an optional DpnI digestion step, an optional PCR purification step, a Nano-Drop step and an optional gel electrophoresis step.
- **NEBuilder HiFi Assembly:** Protocol which makes use of New England Biolabs' HiFi kit in order to assemble DNA. The NEBuilder kit can be seen as superior to the original Gibson Assembly kit as it contains a high-fidelity polymerase.





# iGEM Paris Pasteur

## Why Gibson Assembly?

From the beginning, we realized that the most difficult part of our project would be to assemble all the needed genes as well as the proper intersequences containing the lox sequences into one cluster. We looked at all the possible assemblies and finally settled on Gibson Assembly because it was the fastest method of assembly.

## Experiences

- *How did you experience working with this cloning method?*  
We had some troubles because of the design of our inter-sequences. The lox sequences were actually too close to the overlapping sequence. This caused them to be exposed by the exonuclease and to hybridize together. This caused hindering the polymerization on our Gibson.
- *What was the most difficult task?*  
The most difficult and challenging task for us was to design our operons and the way we would assemble all of our fragments. We also decided to do a linear Gibson Assembly, so we didn't assemble our fragments in a plasmid in order to do a bacterial amplification. We decided to use PCR amplification on our assembled clusters. Using this method required us to do more research and solve more problems.
- *Did the cloning method work as expected?*  
We had a few troubles when we started assembling our clusters but we found ways to change our protocols to improve the yield of our experiments. Once the proper adjustments were made to the protocol, we were able to assemble our clusters without any trouble.
- *What was the biggest achievement using this cloning method:*  
Our biggest achievement using this cloning method was that we were able to assemble a large number of fragments in a small amount of time. We managed to resolve most of the problems we had at first.
- *What would be your tips and tricks if other teams are going to use this method?*  
We would tell you to read all you can find about the Gibson Assembly, and to speak with researchers who use it on a regular basis, if you have the opportunity to do so.

## Materials

- For the design of our overlapping sequences, we used the software Geneious®, which offered free licenses to all of our team members.
- We had to order some of our fragments, mostly the intersequences.
- We used the company MWG Eurofins® for the synthesis of our oligos and primers.
- We used the NEBuilder cloning kit, provided by NEB®, our sponsor.
- Gibson assembly Master Mix.
- TaKaRa Ex Taq polymerase for PCR amplification.

## Designing our Operon

We are assembling an operon of thirteen genes measuring from 460 to 3140 basepairs. In order to find the best possible combination of those genes, we designed our operon in a way that we could use Cre/Lox recombination to test the different combinations. Therefore, we had to insert intersequences between each gene. Those intersequences contain a Lox sequence and are built as such.

However, there is still a high number of possibilities (about six billions), so we decided to divide the genes into four clusters. The clusters have intersequences containing the Lox sequence for one Cre, and the intersequences between the clusters contain the specific sequence for another Cre. This reduces the number of possibilities to about 3500. Therefore, the order of the genes in each cluster can be changed, and the order of the clusters inside the whole operon can be changed, testing a number of possibilities.

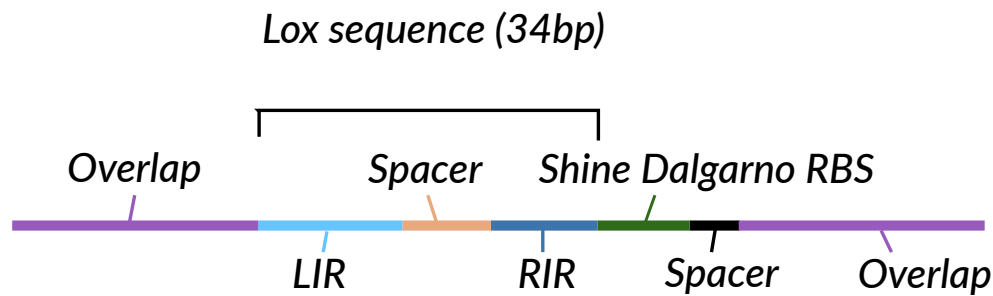

Figure 16 - Showing the design of the Lox sequence of iGEM Paris Pasteur.

## iGEM Paris Pasteur

Our team brings together fifteen bachelor and masters students trained in fields as varied as biology, chemistry, mathematics, journalism and political science and coming from three major Universities in the Parisian region: Pierre et Marie Curie University, Paris Sud University and Sciences Po. We are supervised by ten researchers, post-docs and PhD students within the Pasteur Institute specialized in various fields of research.

This year, we decided to work on hindering the growing problem of plastic pollution. To do so, using *E. coli* as a host, we are designing a bacteria capable of degrading Plastic, specifically PET, and using the degradation products to synthesize Erythromycin A, a commonly used broad spectrum antibiotic.

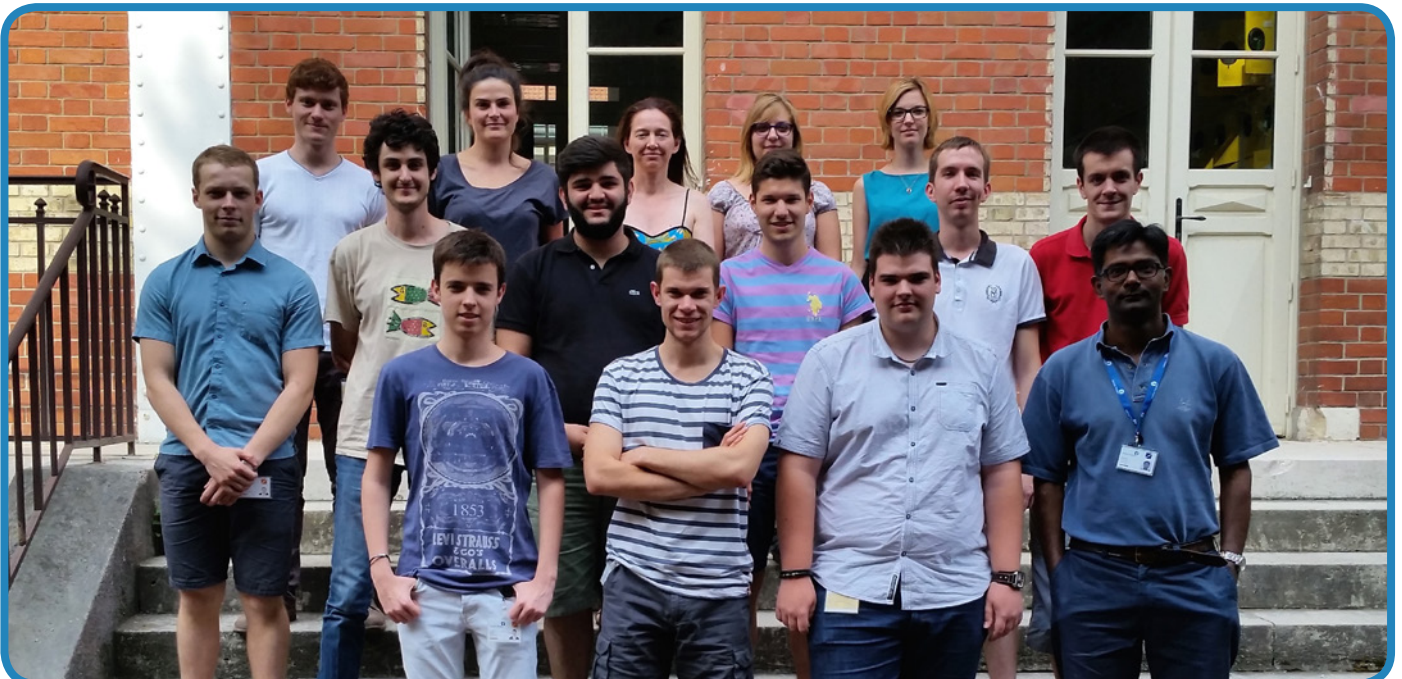

Figure 17 - Team photo of Paris Pasteur with: Mathilde Ananos, Valentin Bailly, Jules Caput, Alma Chapet--Batlle, Maxime Entremont, Lucas Krauss, Florence Moesch Thomas Neff, Kévin Plouchart, Sertac Tas, Amélie Vandendaële, Pierre Vilela

## Why Gibson Assembly?

We chose Gibson Assembly® because we wanted to benefit from IDT's DNA synthesis offer and we considered this technique the optimal method (in terms of speed and efficiency). The use of synthesized oligos requires only small DNA amounts and hence prior cloning steps are not necessary.

## Materials

For (the design of) our experiments, we used the following materials:

- pSB1C3 vector from the Registry of Standard Biological Parts.
- gBlocks® offered by Integrated DNA Technologies®.
- Primers by Integrated DNA Technologies® (up to 60bp).
- The NEBuilder® Cloning Kit, supplied by New England Biolabs.
- SnapGene®
- The Q5-High Fidelity Polymerase Master Mix offered by New England Biolabs®.
- Phusion® High-Fidelity DNA Polymerase by New England Biolabs®.
- GoTaq G2 by Promega® (for colony PCR screens).
- Zymoclean™ Gel DNA Recovery Kit by Zymo Research®.
- DarkReader® - Blue Light Transilluminator.
- SYBR Safe®.
- SureVector® MasterMix by Agilent Technologies, Inc. (a polymerase cycling assembly (PCA) kit that can be used for the assembly of multiple overlapping fragments) - planned to use it as a back up of the NEBuilder®.

## Protocols

iGEM team York has collected all their protocols on the following page. These protocols were used to perform their own Gibson Assembly and it shows their specific details on lab work.



## Experiences

- *How did you experience working with this cloning method?*  
The Gibson Assembly worked reliably when the DNA fragments and vector were highly purified and in the proper molar ratios. In our experience, small levels of contamination (eg. Non-specific amplification from genomic DNA or colony PCR) that escape PCR purification can cause downstream issues in the cloning of large protein-coding genes and growth-impeding proteins.
- *What was the most difficult task?*  
We designed a synthetic operon that contains 4 protein-coding cistrons. We wanted to be able to assemble several (interchangeable) variations of the operon with some deleted protein domains and a variant without one of the proteins and to be able to do this with the least amount of gBlocks. We had to design short adapters to link each gene fragment flanking the domain deletions and incorporate restriction enzyme sites surrounding the above-mentioned protein.
- *Did the cloning method work as expected?*  
The cloning of fragments up to 2.1 kb worked as expected (from first attempt). As noted by the developers, larger fragments are harder to assemble. We have successfully cloned fragments of total size of 450 bp, 1116 bp, 2100 bp and. We have also assembled large constructs with long PCR products (3600 bp and 4800 bp). The PCR products are derived from Colony PCR reactions with a high-fidelity polymerase. The Colony PCR reaction we used was a touch-up colony PCR with primers that contain overhangs. Since the initial annealing is partial, the annealing temperature has to be lower than the annealing temperature of the whole primer with the overhang. We also managed to perform site-directed mutagenesis simultaneously with our cloning and assembly.
- *What was the biggest achievement using this cloning method?*  
The biggest achievement has been cloning a 4.8 kb Phosphate-specific ABC transporter from *Sinorhizobium meliloti* as one big Colony PCR product. It was difficult to purify the PCR product as large DNA fragments are tightly bound to the silica membrane of the purification column we were using. Extra elution steps at high temperature were required.
- *What would be your tips and tricks if other teams are going to use this method?*  
We would recommend gel extraction using a Zymo Gel Extraction kit (or similar) which has a smaller elution volume (>6 uL) and a smaller membrane delivering more concentrated eluates. Also, we got really good results using SYBR Safe and Dark Reader Blue-Light Transilluminators. We think our higher success rate may be due to lower levels of DNA damage induced by the blue light as opposed to UV light. When cloning big protein-coding inserts like ours it is best to keep their expression repressed when screening for the correct product.

We also recommend doing all controls for the vector 5'-end vector dephosphorylation reaction and we recommend performing a gel extraction of the linearized vector if it contains a "placeholder" insert. The control reaction is a self-ligation reaction and subsequent transformation.

To troubleshoot Gibson Assembly Reaction, we did PCR controls of the reaction. In some cases, we plan to use sequential Gibson Assembly - where the final product is assembled in steps (vector is added after several fragments have been joined), the Gibson Assembly product can be itself used as a template for downstream applications.

## iGEM York

Our team is a group of undergraduate students that have an interest in synthetic biology and chose to investigate how to prevent eutrophication caused by downstream runoff from wastewater treatment plants. In particular, we have spent the summer designing *E. coli* to remove phosphate out of wastewater in bioreactors of wastewater treatment plants. We are 10 undergraduates, 1st, 2nd, 3rd and 4th years that study either biology, chemistry or biochemistry at the university. We have had supervision from a few PhD students as well as several lecturers in the department.



Figure 18- Team photo of York, from left to right;  
back row- Ivan Gyulev, Jun Hee Jung, Adam Brain, Joseph Tresise, Matthew Higgins,  
front row- Katy Davis, Erin Cullen, Kristina Aare, Mat Milner, Abi Robowtham, Clare Draper,  
Liz Alexianu.

### References:

- [1] Gibson et al., "Complete chemical synthesis, assembly, and cloning of a *Mycoplasma genitalium* genome," *Science*, 319:1215–20, 2008.
- [2] Gibson et al., "Enzymatic assembly of DNA molecules up to several hundred kilobases," *Nat Meth*, 6:343–5, 2009.

# In-Fusion Cloning™

## Introduction

In-Fusion cloning™ method is used for directional cloning of one or more fragments of DNA into any vector. The cornerstone of In-Fusion cloning™ technology is Clontech's proprietary In-Fusion™ Enzyme, which fuses DNA fragments by recognizing a 15 bp overlap at their ends (Figure 19). This 15 bp overlap can be engineered by designing primers for amplification of the desired sequences.

**Step 2 -** Design PCR primers for your gene of interest with 15 bp extensions (5') that are complementary to the ends of the linearized vector

**Step 1 -** Select a base vector and identify the insertion site. Linearize the vector by restriction enzyme digestion or inverse PCR and purify

**Step 3 -** Amplify your gene of interest. Verify on agarose gel that your target DNA has been amplified and determine the integrity of the PCR product

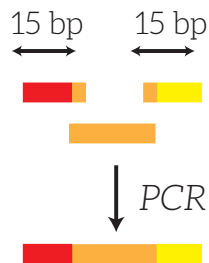

**Step 4 -** Spin-column purify your PCR product OR treat it with Cloning Enhancer

**Step 5 -** Set up your In-Fusion cloning reaction

**Step 6 -** Transform competent cells with the reaction mixture

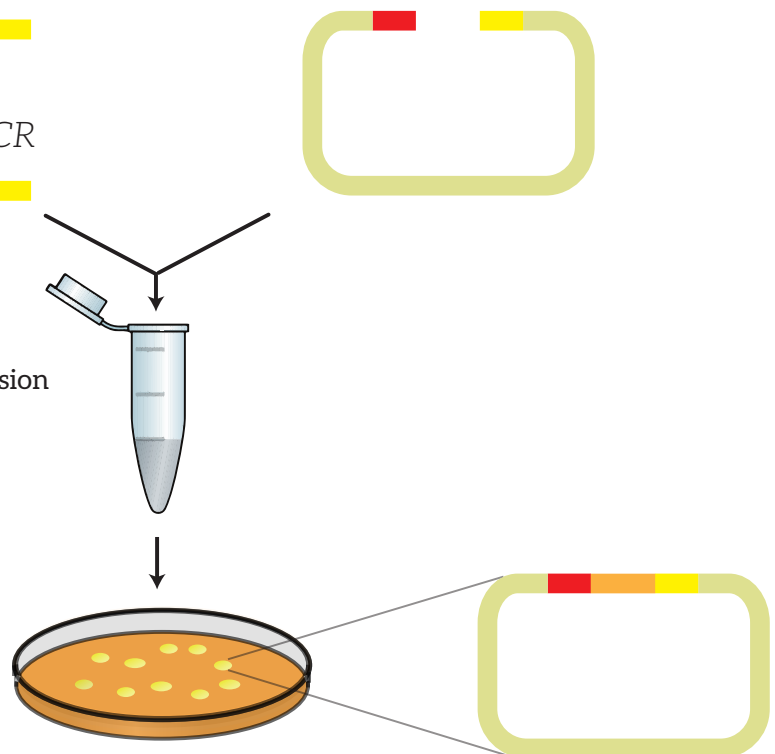

Figure 19- An overview of the In-Fusion Cloning™ Protocol.

## Points of interests

- Primer design and quality are critical for the success of the In-Fusion™ reaction. In-Fusion™ allows you to join two or more fragments, vector and insert (or multiple fragments), as long as they share 15 bases of homology at each end. Therefore, In-Fusion™ PCR primers must be designed in such a way that they generate PCR products containing ends that are homologous to those of the vector.
- In-Fusion™ and Gibson Assembly resemble each other, they both rely on the 3' → 5' exo-nuclease activity of an enzyme which produces single stranded ends (Figure 20). The main difference between these methods is the fact that the repair/ligation activity occurs *in vivo* while using In-Fusion™. This characteristic has three direct consequences displayed in red in the disadvantages below.

### 3' --> 5' exonuclease activity of poxvirus DNA polymerase

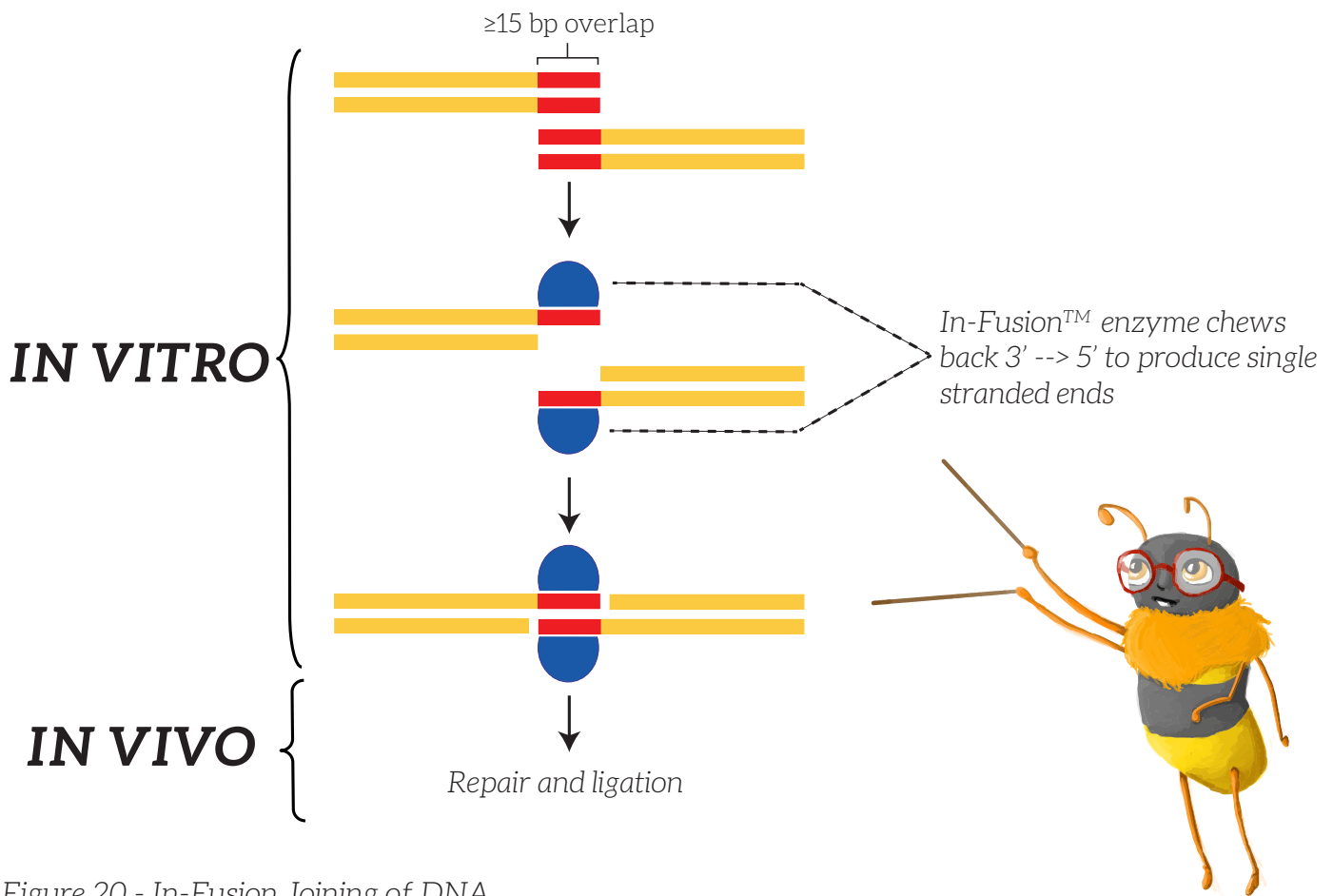

Figure 20 - In-Fusion Joining of DNA

#### Advantages

- Clone any insert, into any location, with any vector of your choice.
- Efficiently clone a broad range of fragment sizes.
- Clone multiple DNA fragments simultaneously into any vector within a single-tube reaction.
- No restriction digestion, phosphatase treatment or ligation is required.
- Final constructs are seamless with no extra or unwanted base pairs.
- Possibility to assemble large gene fragments and generation of gene libraries.

#### Disadvantages

- Experiments and especially primer design must be scrupulous.
- As this method is based on homologous recombination technology, it does not work in any microorganisms (probably due to different repair systems).
- Cloning (repair ligation) occurs in vivo. Therefore, you cannot check the integrity of your construction before transformation.

## Applications:

- Join multiple pieces of DNA within a single reaction (see Figure 21).
- Insertion of point mutations (see Figure 20).
- Delete and replace whole segments of DNA.
- Insert introns within cDNA.
- Create modular expression vectors with interchangeable parts.
- Swap domains on a gene.
- Create seamless fusion proteins.

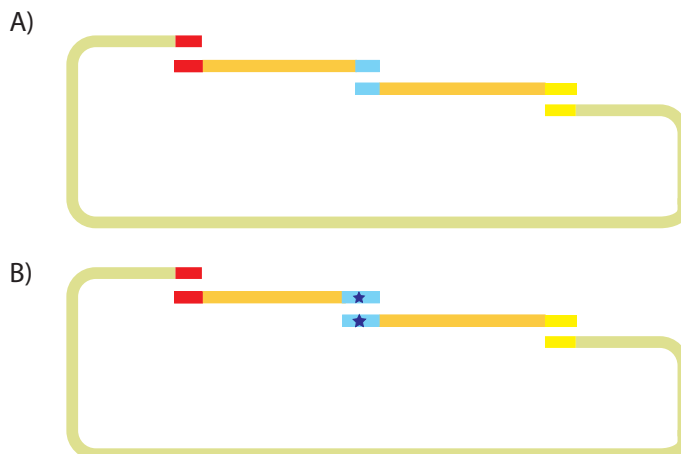

Figure 21- (A) Multiple and directional cloning, (B) A DNA mutation strategy

## Frequently Asked Questions

- *What is the largest DNA fragment compatible with In Fusion Cloning™?*  
DNA inserts up to 15 kb have been successfully cloned into pUC19 using In-Fusion Cloning
- *What is the smallest DNA fragment compatible with In-Fusion Cloning™?*  
The smallest insert successfully cloned with In-Fusion Cloning was a 50 bp oligonucleotide (including two 15-nt homologous overlaps with the vector termini). For In-Fusion Cloning of short synthetic oligos (between 50 and 150 bp), the suggested oligo to vector molar ratio is 5–15:1
- *Can I use electroporation to transform the In-Fusion Cloning™ reaction mix?*  
1 µl of 1:5 diluted In Fusion Cloning™ reaction mix can be electroporated into 50 µl of electro-competent bacterial cells.
- *What bacterial strains are compatible with In-Fusion Cloning™ ?*
  - o In-Fusion Cloning™ requires bacterial cells with competency no less than 108 cfu/µg supercoiled DNA. The In-Fusion™ Plus kits are supplied with Stellar Competent Cells, so these cells may be a good starting point.
  - o It is not recommended to use In-Fusion™ on the following:
    - TOP10 cells or their derivatives (e.g., ccdB Survival 2T1R E.coli) and related strains (e.g. DH10B, MC1061) are less optimal for In-Fusion cloning™, resulting in a lower number of recombinant clones. This may be of particular concern if you are performing multiple-fragment cloning, or using a low-copy vector.
    - E.coli strains lacking recA1 or endA mutations.
    - E.coli strains engineered for a particular application (e.g. large-scale protein expression).
    - Gram-positive bacterial strains.
    - Bacterial cells carrying nupG (deoR) mutations.





# iGEM Toulouse

## Why In-Fusion Cloning™?

This technology ensures easy, single-step, directional cloning of any gene of interest into any vector at any locus. In-Fusion™ constructs are seamless, enabling translational reading frame continuity without any interfering “scar” sequences.

## Design Considerations

1. Every In-Fusion™ primer must have two characteristics:  
The 5' end of the primer must contain 15 bases that are homologous to 15 bases at the end of the DNA fragment to which it will be joined (i.e., the vector or another insert).  
The 3' end of the primer must contain a sequence that is specific to the target gene.
2. The 3' portion of each primer should:
  - a. be target gene-specific.
  - b. be between 18-25 bases in length and have a GC-content between 40–60%.
  - c. have a melting temperature ( $T_m$ ) between 58–65°C. You can use Oligocalc to work it out. The  $T_m$  difference between the forward and reverse primers should be  $\leq 4^\circ\text{C}$ , or you will not get a good amplification. Note: The  $T_m$  should be calculated based upon the 3' (gene-specific) end of the primer, and NOT the entire primer. If the calculated  $T_m$  is too low, increase the length of the gene-specific portion of the primer until you reach a  $T_m$  of between 58–65°C.
  - d. not contain identical runs of nucleotides. The last five nucleotides at the 3' end of each primer should contain no more than two guanines (G) or cytosines (C).
3. Avoid complementarity within each primer to prevent hairpin structures, and between primer pairs to avoid primer dimers.
4. You can perform a BLAST search to determine if the 3'-end of each primer is unique and specific.
5. Clontech provides an online tool that simplifies In-Fusion PCR™ primer design for standard cloning reactions. Simply provide your vector sequence, the restriction enzyme(s) used to linearize the vector (if that is the chosen method for linearization), and the primer sequence required to amplify your region of interest.



Following PCR, verify by agarose gel electrophoresis that your target fragment has been amplified. If a single band of the desired size is obtained, you can EITHER spin-column purify, OR treat your PCR product with In-Fusion™ Cloning Enhancer. However, if non-specific background or multiple bands are visible on your gel, isolate your target fragment by gel extraction, then spin-column purify.

The setup of the In-Fusion cloning™ reaction Mix and the transformation that follows depend on the chosen method (Refer to the In-Fusion™ HD Cloning Kit guide).

## Materials

For (the design of) our experiments, we used the following materials:

- In-Fusion™ HD Cloning Kits:
  - 2 µl of 5X In-Fusion™ HD Enzyme Premix
  - X µl of Linearized Vector
  - X µl of insert
  - X µl of dH<sub>2</sub>O to a total reaction volume of 10 µL
- Primer design software (we used Serial Cloner)
- Miniprep Kit (We used the QIAprep Spin Miniprep Kit)

## Experiences

- *How did you experience working with this cloning method?*  
Everything went as expected.
- *What was the most difficult task?*  
The main difficulty was to design PCR primers that fitted (with the help of someone experienced preferentially)
- *Did the cloning method work as expected?*  
Yes
- *What was the biggest achievement using this cloning method?*  
Cloning a small piece of RNA successfully!
- *Why did you choose this cloning method?*  
This method is well-established in E. coli and permits transformation with high efficiency, which is a big advantage when cloning small inserts.

## Additional information

- Clontech has made a short video in which they dive into the workflow of In-Fusion Cloning™.



- Clontech has placed an advert in Nature Communications in which they discuss the efficiencies and possibilities of In-Fusion HD Cloning™.

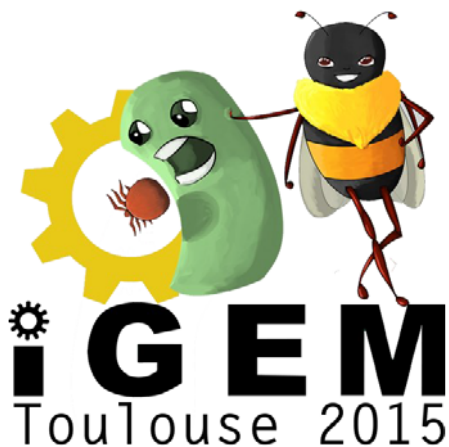

## iGEM Toulouse

Our Team is composed of eleven students, seven engineering-students in fourth year of Biochemical engineering at INSA Toulouse and four students in Microbiology and Bio-informatics at the University of Toulouse Paul Sabatier. Furthermore eleven professors (INSA, UPS, INRA, CNRS) advise us. Diversity is a key aspect of our team due to the complementarity of the different formations offered by our University.



Figure 22- Team photo of iGEM Toulouse. Melany Tanchon, Anthony David, Thomas Exteberry, Benoit Pons, Marine Pons, Alexandre Le Scornet, Laetitia Chaumont, Blandine Trouche, Melissa David & Louise Gody

## Protocols

The protocols of team Toulouse describe varroa tests, culture tests, RbCl method and cloning. Each of the protocols is described in more detail on the wiki of team Toulouse.

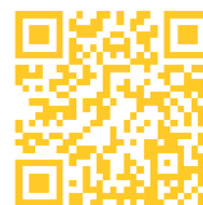

### References :

- [1] Bird, L.E., Rada, H., Flanagan, J., Diprose, J.M., Gilbert, R.J.C. and Owens, R.J. (2014). Application of In-Fusion™ cloning for the parallel construction of E. coli expression vectors. *Methods Mol. Biol.* Clifton NJ 1116, 209-234.
- [2] Zhu, B., Cai, G., Hall, E.O. and Freeman, G.J. (2007). In-fusion assembly: seamless engineering of multidomain fusion proteins, modular vectors, and mutations. *BioTechniques* 43, 354-359.
- [3] In-Fusion® HD Cloning Kit User Manual

# Iterative Capped Assembly

## Introduction

Iterative Capped Assembly (ICA) is a cloning method that is used to sequentially assemble long, repetitive DNA sequences. This technique was developed by Briggs et al. in 2012 as a method to assemble Transcription Activator-Like Effector Nucleases (TALENs) which are sequence specific DNA binding proteins that consist of multiple repetitive monomers [1]. Each repeat monomer is responsible for binding to a specific nucleotide in the target sequence. Due to the repetitive nature of TALE genes, conventional PCR is unable to reliably amplify these sequences due to non-specific primer binding.

Although ICA was developed using TALE construction as a model problem, this technique can be used to construct long, repetitive DNA constructs in a directly controllable fashion. ICA assembles repetitive sequences one monomer at a time, while preventing the elongation of incomplete nucleotide chains. The full length sequence is flanked by unique primer annealing sites, which allows the PCR amplification of the final product. This entire process is performed using a solid substrate, which greatly facilitates the construction of long sequences.

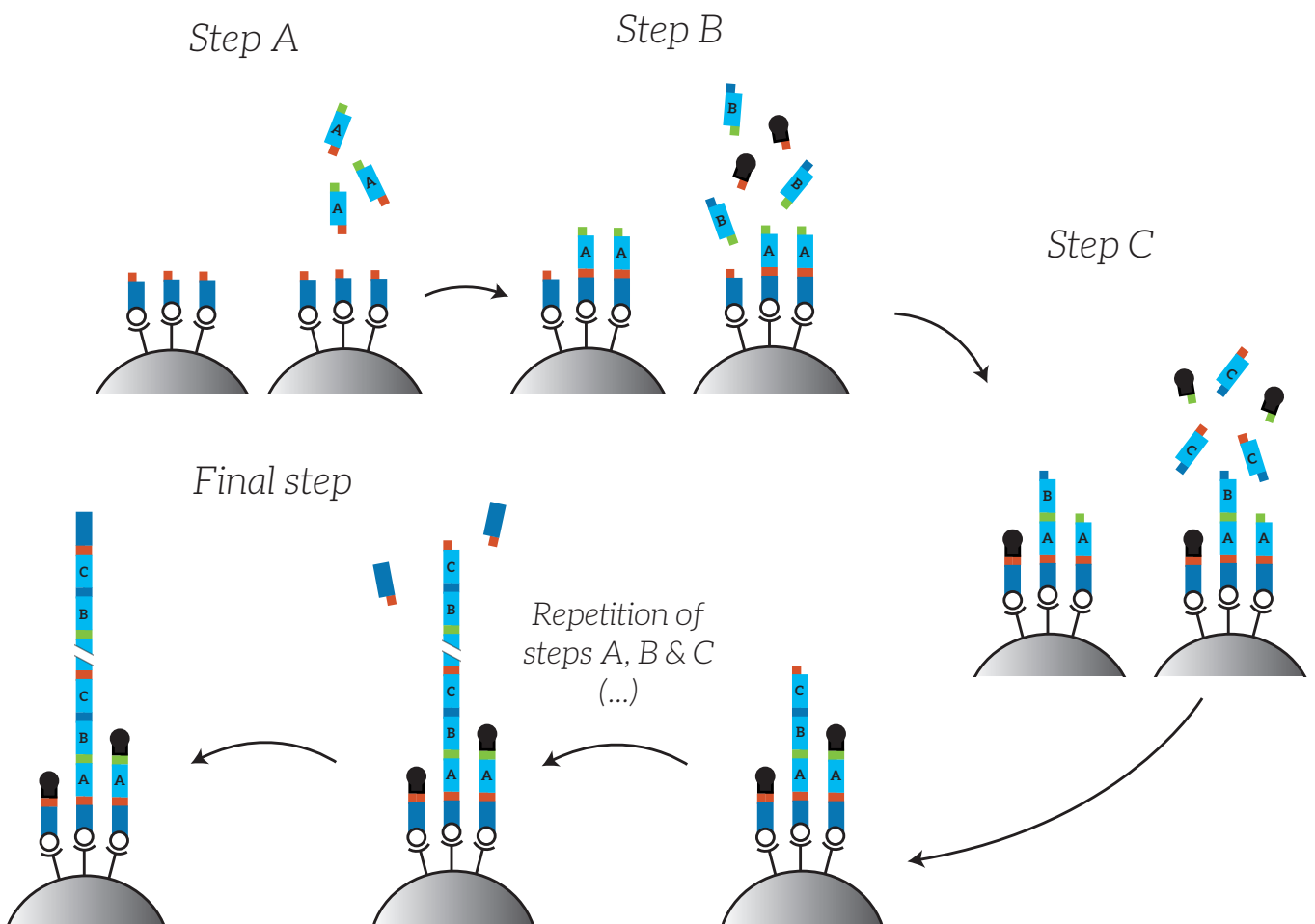

Figure 23 - Workflow overview of Iterative Capped Assembly. Monomers are attached to a growing chain of DNA in an A-B-C fashion. The growing chains are immobilized on streptavidin beads. Unreacted chains are capped to prevent them from growing further. This image was adapted from Briggs et al.

## The Steps

Iterative capped assembly is similar to Golden Gate assembly, which uses unique sticky ends to assemble gene fragments in a specific order. Whereas Golden Gate is a one-pot reaction with all the pieces ligated simultaneously, ICA is a more controlled variation where pieces are assembled one at a time. ICA relies on using 3 different versions of the monomer to be assembled, each of which has different sticky ends such that the monomers must be assembled in an A-B-C fashion. This prevents monomers from self-ligating. Type IIS restriction enzymes, which cleave outside of the recognition site are used to generate these.

In each extension step, the next sequential monomer (A, B, or C) is added onto the growing chain (See Figure 23). Chains that were not extended during the previous extension step are capped using a hair-pin oligo that prevents subsequent extension. These capped chains remain present in the mixture for the duration of ICA, but do not participate in ligation events. Each final construct is flanked by a biotinylated initiator oligo which allows immobilization onto streptavidin beads, and a terminator oligo. These two oligos provide primer annealing sites which can be used to amplify the sequence using conventional PCR (see Figure 24). The capped chains are not amplified in this PCR as they lack the terminator oligo.

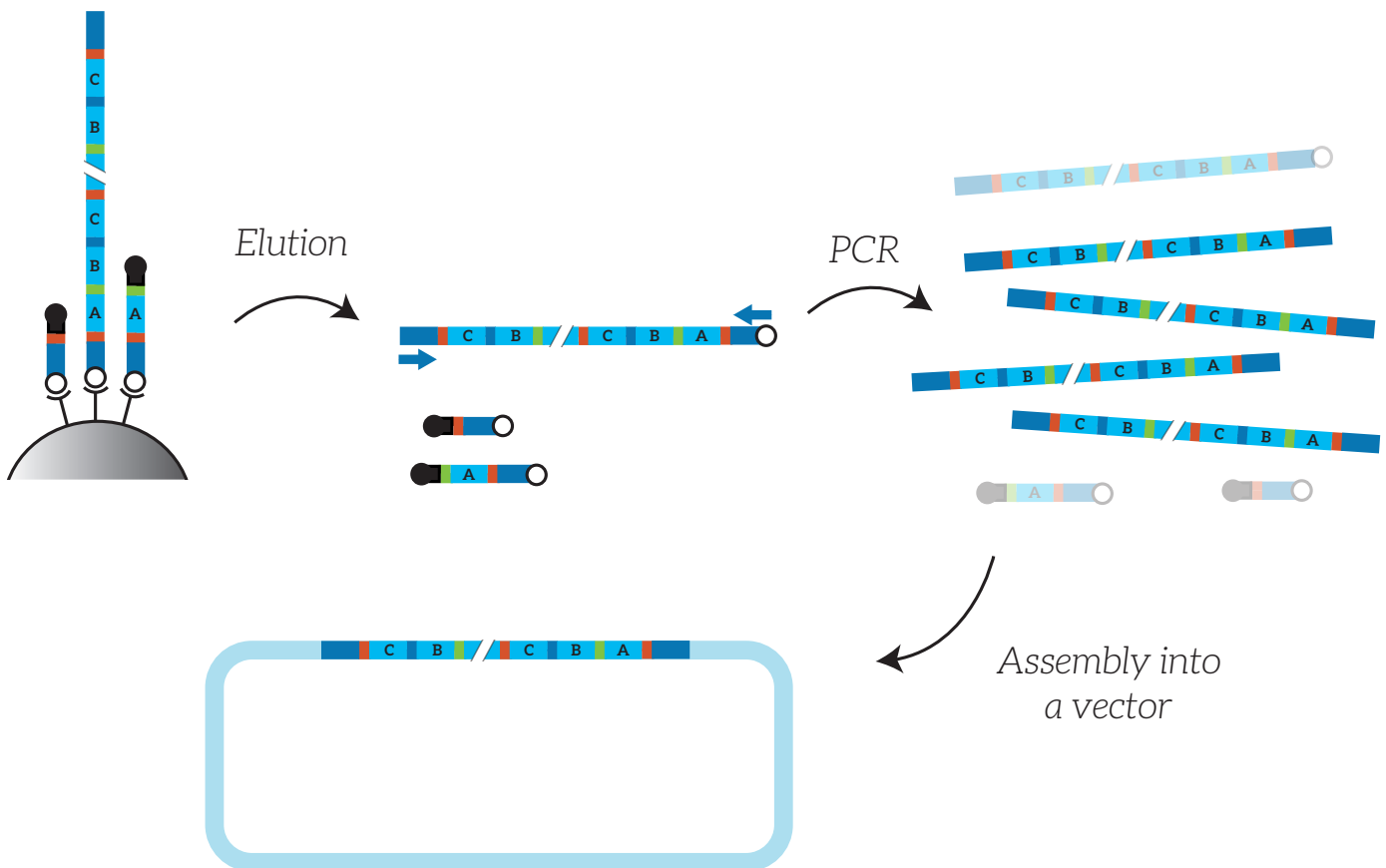

Figure 24 - After the polymer has been constructed on the beads, they are eluted from the beads. The eluate is used as a template for PCR to amplify the construct. Only complete constructs that contain initiator and terminator are amplified. Capped oligos are not amplified as they lack the primer binding site.

## Points of interests

- The ICA monomers are generated using type IIS restriction enzymes (e.g. *BsaI*), which cleave asymmetrically outside of the recognition site. It is of the utmost importance that your DNA does not contain these sites elsewhere, particularly within your monomer.
- ICA is the only method within this cloning guide that assembles DNA constructs on a solid substrate.
- The initiator, terminator, and capping oligos are prepared ahead of time by mixing the relevant oligos and ramping down from 95°C to form the working oligos.

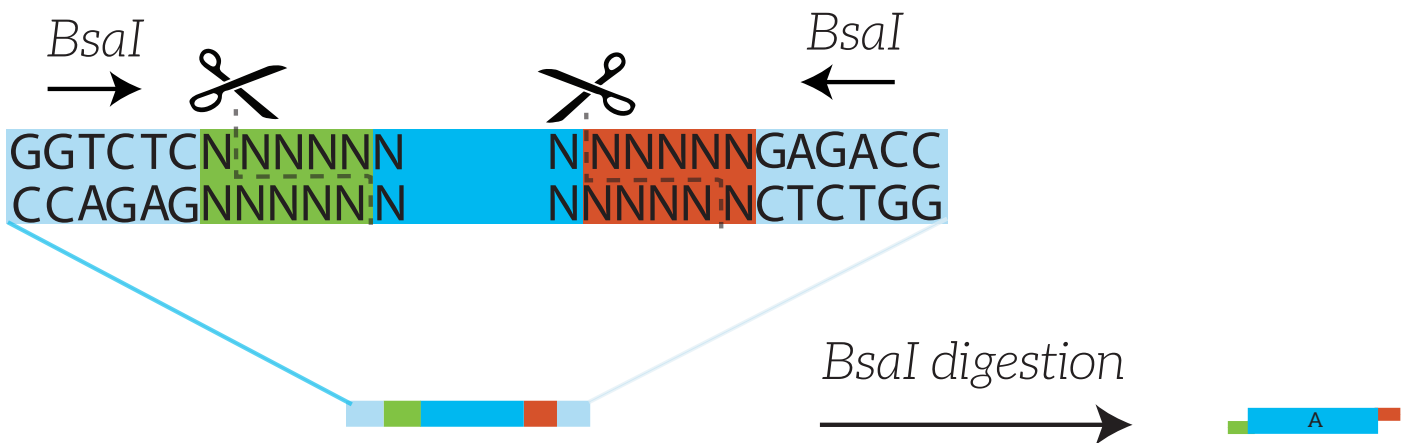

Figure 25 - Parts are generated by digestion of the monomers by the *BsaI* restriction enzyme. Even though the core monomers remain the same (darker blue), the sticky ends differ for each different unit.

## The Pieces

A basic biobrick for ICA consists of a gene monomer flanked by *BsaI* recognition and cleavage sites. While each of the core monomer is identical, the restriction sites are oriented such that digestion with *BsaI* yields distinct sticky ends for each of the three types of units. These pieces must be digested to reveal the sticky ends before assembly (see Figure 25).

Accessory pieces in ICA include the initiator, streptavidin coated beads, the terminator and the capping oligos (see Figure 26):

- The initiator: a dsDNA fragment made by annealing two ssDNA oligos together. The initiator is designed such that one end is biotinylated, for conjugation to streptavidin coated beads. The other has a sticky overhang and is designed to anneal to the forward sticky end of the 'A-type' monomer unit. This end is 5'-phosphorylated to enable ligation. The initiator also contains a primer binding site that can be used for PCR amplification, as well as other accessory sequences such as affinity tags and the BioBrick prefix.
- Streptavidin coated beads: these beads serve as a solid support for the elongating DNA chain during ICA. The biotinylated end of the initiator binds to streptavidin to anchor the nascent construct. The ability to physically separate the DNA from solution is needed due to repeated wash and ligation steps used during ICA.
- The terminator: a dsDNA fragment that is constructed similarly to the initiator, but lacks biotinylation. One end of the terminator is compatible to the reverse sticky end of the 'C-type' monomer unit. This end is 5'-phosphorylated to enable ligation. The terminator also contains a primer binding site that can be used for PCR amplification, as well as the bio-brick suffix.
- The capping oligos: structures that are comprised of a single 5'-phosphorylated ssDNA oligo that can form a stable stem loop structure with a unique sticky end. There are three distinct caps, each of which can bind to the A, B, or C sticky ends.

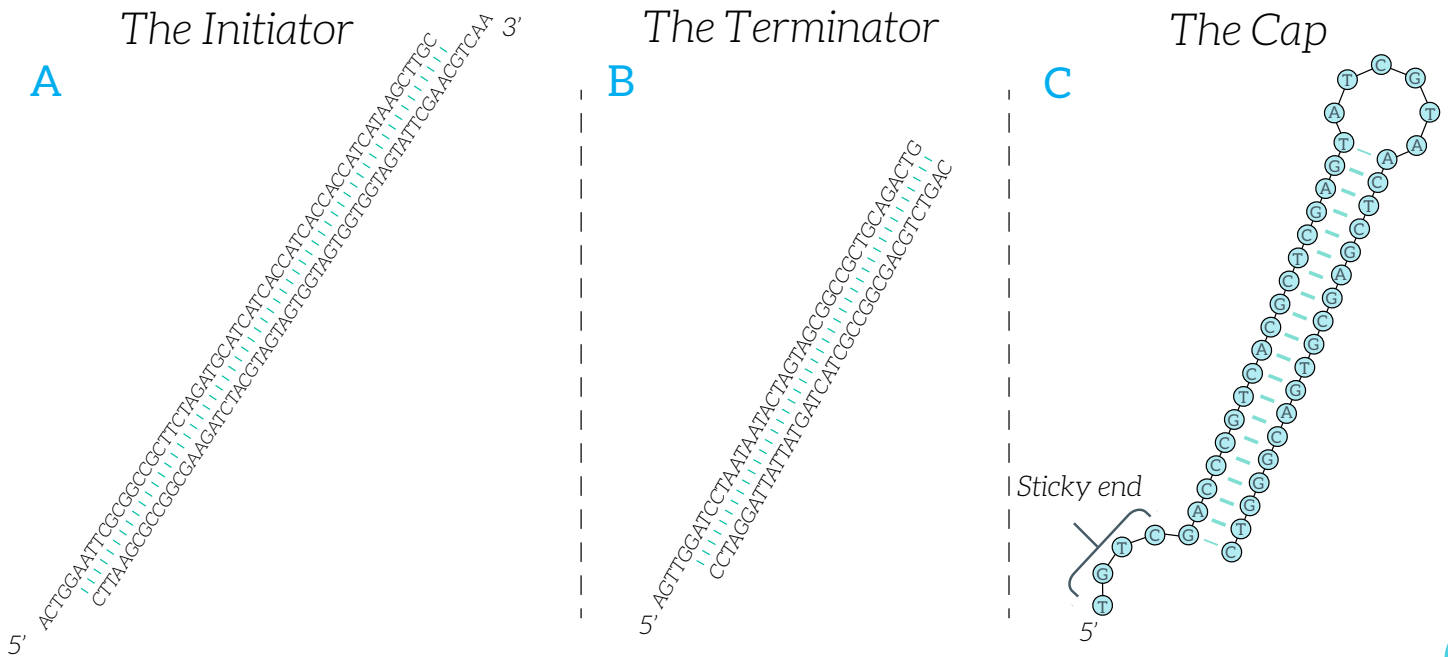

Figure 26- Overview of the pieces which play a role in ICA. (A) The 5' end of the top strand (ACTG) is biotinylated, and the 5'-end of the bottom strand (TCAA) is phosphorylated. TCAA is the reverse complement of the 'A' sticky end. The initiator contains the biobrick prefix, start codon, and 8X His Tag. (B) The 5'-end of the top strand of the terminator is phosphorylated. The sticky end on the terminator is AGGT, which is the 5' sticky end. (C) The capping oligos have a hairpin secondary structure. The stem-loop sequence is the same for all three caps. The only difference is the sticky ends present. The image shows the 'A' sticky end. Secondary structure prediction courtesy of the Predict a Secondary Structure Web Server by the Mathews group.

### Advantages

- ICA is specifically designed for assembly of modular, repetitive sequences. It is thus very good with these sequences.
- Assembly of repetitive gene sequences is difficult with more conventional techniques involving PCR.
- The sticky parts used in ICA are very interchangeable, and it is possible to assemble anything, as long as the proper sticky ends are in place.
- ICA can be designed to be a scarless assembly, but it does not necessarily need to be.

### Disadvantages

- ICA is difficult: it is less well suited than Golden Gate Assembly or Gibson Assembly when constructing non-repetitive sequences.
- Difficulty of using ICA as a routine assembly method arises from needing to introduce the required sticky ends through end-extension PCR.

## ICA vs. Golden Gate

- Both ICA and Golden Gate Assembly rely on the use of type IIS restriction enzymes to create compatible sticky ends that can no longer be cleaved after being joined.
- ICA and Golden Gate have the ability to assemble multiple pieces by designing unique sticky ends. However, Golden Gate Assembly is limited in the number of parts that can be assembled within a single reaction, due to the combinatorial limitation of sticky ends.
- ICA is like a controlled Golden Gate Assembly where one piece is assembled at a time, rather than all simultaneously. This removes the need for many unique sticky ends, and allows for the reuse of sticky end sequences as well as increasing the possible length of the final construct. However, the tradeoff is that each piece must be assembled individually, which can significantly lengthen the process.

## Frequently Asked Questions

- *How long does ICA take?*  
Depending on the length of the final construct and ligation times, ICA can take 3-5 hours. From our experience, ICA for a 12-mer construct takes 3 hours from placing the first monomer onto the beads, to eluting the final construct.
- *Are there other Type IIs restriction enzymes that can be used instead of BsaI?*  
Other Type IIs restriction enzymes exist, such as FokI. These can certainly be used, and the resulting constructs should be made to accommodate the new recognition site. Most Type IIs restriction enzymes cleave DNA so that there is a 4 base pair sticky end. If another enzyme is chosen that leaves a different length sticky end, this difference should be taken into consideration, particularly if the final DNA assembly is a coding sequence.
- *Are there any special considerations when designing the A, B, C sticky ends?*  
Yes, the A, B, C sticky ends should be unique and should not be able to bind to each other. When working with four base pair sticky ends, there should be at least a two nucleotide difference between the A, B, and C sticky ends. Finally, there should be no more than 2-3 GC pairs in each sticky end and no GC residues on the terminals of the sticky ends.
- *How many pieces can be assembled using ICA?*  
Our team has (as of August 2015) assembled up to 17 DNA pieces sequentially, totaling about 1.6 kb. We have found this process to be fairly accurate, with few single base pair mutations, and virtually no incorrect monomer incorporation. Literature indicates that ICA has been used to assemble 21 DNA pieces, totaling about 1.9 kb.
- *What are typical yields from ICA? How reliable is it?*  
ICA itself yields DNA in sub-nanogram amounts. ICA in general is reliable, but requires precision when setting up the reactions. ICA is sensitive to mistakes in preparing the ligation reactions. For example, using the wrong cap in one reaction is enough to render the entire assembly unusable.

## Useful resources

The Predict a Secondary Structure server is an online tool which can predict the secondary structure of an arbitrary sequence. The tool can be used to predict the hairpin of the cap.





## Why Iterative Capped Assembly?

UCLA iGEM is working on creating and expressing silk from customizable spider silk genes, which contain many repetitive sequences assembled sequentially. We thought that ICA would be perfect for our project because it allows us a high level of control over the construction of our silk genes.

## Materials

- Streptavidin-coated beads are essential for this method: they act as the solid substrate for the elongating DNA chain. We used M-270 streptavidin coated Dynabeads from Invitrogen®.
- A highly selective DNA ligase is preferred, such as T7 DNA Ligase, since correct assembly of the A, B and C monomers is critical. We used T7 DNA Ligase from NEB®.
- A type IIS restriction enzyme. We used BsaI from NEB®.
- Standard cloning materials are needed for upstream and downstream processing of parts. We used Q5 HF DNA Polymerase for PCR, DH5α E. coli for plasmid amplification, oligos and constructs from IDT and purification kits from Invitrogen®, Zymo® and Qiagen®.

## Design considerations

- The sticky ends that differentiate the A, B and C pieces must differ by at least two base pairs (between the A, B and C pieces), and must not have GC residues on the ends of the annealing region. Avoid more than 2-3 GC pairs in the sticky ends. The sequences we used are shown in Figure 27.

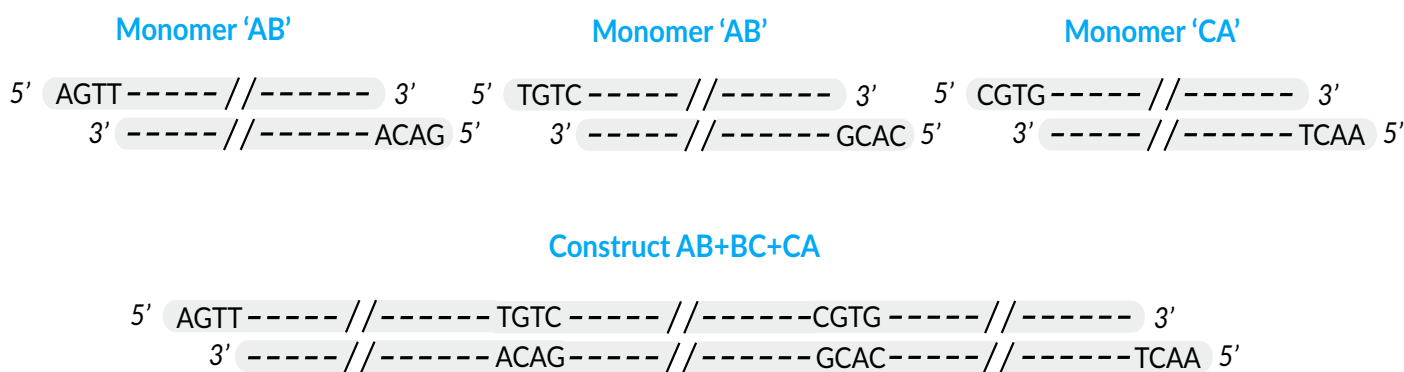

Figure 27 - Diagram of individual ICA monomers with corresponding sticky ends. The monomers are named after the sticky ends that they possess on the 5'- and 3'-ends, respectively. An assembled 3-mer construct is shown, but without the initiator, terminator or caps.

## Experiences

- *How did you experience working with this cloning method?*  
ICA worked well for us, and we were able to implement it to assemble spider silk genes in a customizable, modular fashion.
- *What was the most difficult task?*  
Performing ICA to assemble your gene is the most difficult and time consuming task. Depending on the size of the final construct, you may expect to tend to a reaction continuously for three to four hours. With practice, a long construct may be assembled in as little as two hours. On the other hand, preparing and designing the pieces used in ICA, and the workflow of pieces generated after ICA are fairly simple.
- *Did the cloning method work as expected?*  
No, but we did get it to work. ICA is sensitive to the specific sequence of the sticky ends on the monomers, and may not work properly depending on the exact nucleotide sequence you wish to construct. See the design protocol for more details.
- *What was the biggest achievement using this cloning method?*  
ICA was used successfully to construct our spider silk genes. This validates the ability of ICA to work for modular repetitive sequences.
- *What would be your tips and tricks if other teams are going to use this method?*  
When planning to perform ICA, set aside a block of about 3-4 hours. In addition, you will need a set of micropipets, which you will be using for the entire time. It is best if these pipets are not shared with the rest of the team. In addition, it is helpful to prepare each extension reaction ahead of time, so the total time spent doing ICA is shortened.

## UCLA iGEM

UCLA iGEM is working on creating and expressing silk from customizable spider silk genes, which contain many repetitive sequences assembled sequentially. We thought that ICA would be perfect for our project because it allows us a high level of control over the construction of our silk genes.

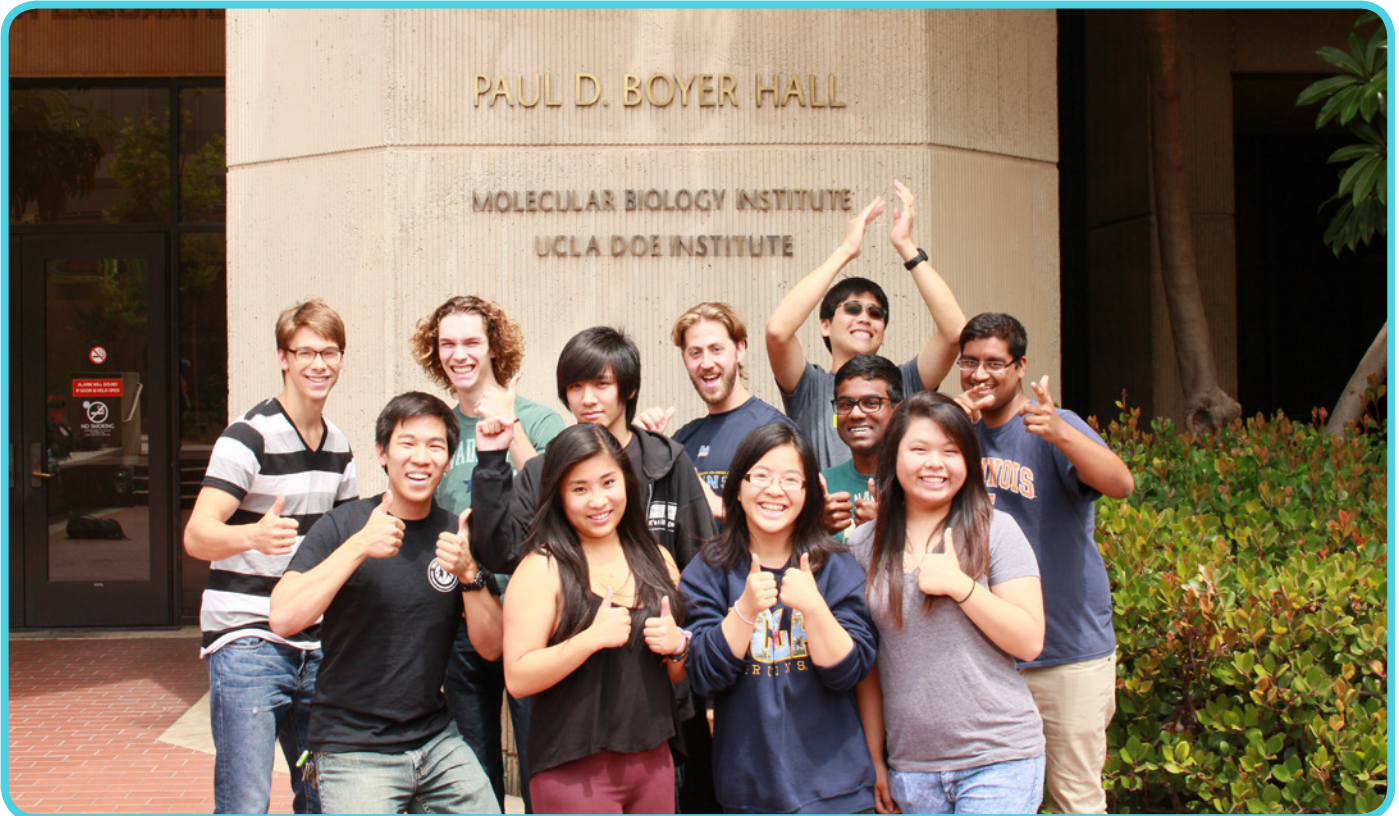

Figure 28 -UCLA iGEM Team in front of Boyer Hall, which houses the Molecular Biology Institute and the UCLA-Department of Energy (DOE) Institute. Back Row (Left to Right): Carter Allen, Tyler Lee, Tristan Joseph, Vinson Lam. Middle Row (Left to Right): Michael Cheng, Phillip Nguyen, Nithin Dharmaraj, Fasih Ahsan. Front Row (Left to Right): Megan Satyadi, Jessica Huang, Olivia Cheng.

## Protocols

- Making MaSp ICA Monomers
- ICA Oligo Sequences
- ICA Preparation



## References:

[1] A. W. Briggs, X. Rios, R. Chari, L. Yang, F. Zhang, P. Mali, and G. M. Church, "Iterative capped assembly: rapid and scalable synthesis of repeat-module DNA such as TAL effectors from individual monomers.," *Nucleic Acids Res.*, vol. 40, no. 15, p. e117, Aug. 2012.

# Golden Gate Assembly

## Introduction

Golden Gate Cloning was first developed in 2008. It was devised in order to make a technology of cloning that was fast, efficient, and did not leave cloning scars [1]. This cloning technique uses type IIS restriction enzymes and T4 DNA ligase. This enables assembly of multiple DNA parts in what is often referred to as a “one-pot, one-step” reaction (see Figure 29). This is achieved, because type IIS restriction enzymes cut outside of the recognition sequence, so the overhangs produced by the enzyme can be user-defined. This characteristic allows multiple parts to be assembled in pre-determined order and orientation in a single step. Golden Gate Cloning also involves the changing of antibiotics between parts and acceptors. This allows for the selection of only the desired construct. Steps like PCR and gel purification can be skipped [2]. There are various assembly standards within Golden Gate Cloning which assign specific overhangs to different types of parts (e.g. promoters, coding sequences, terminators) so assembly is no longer scarless but parts are standardized and interchangeable between labs.

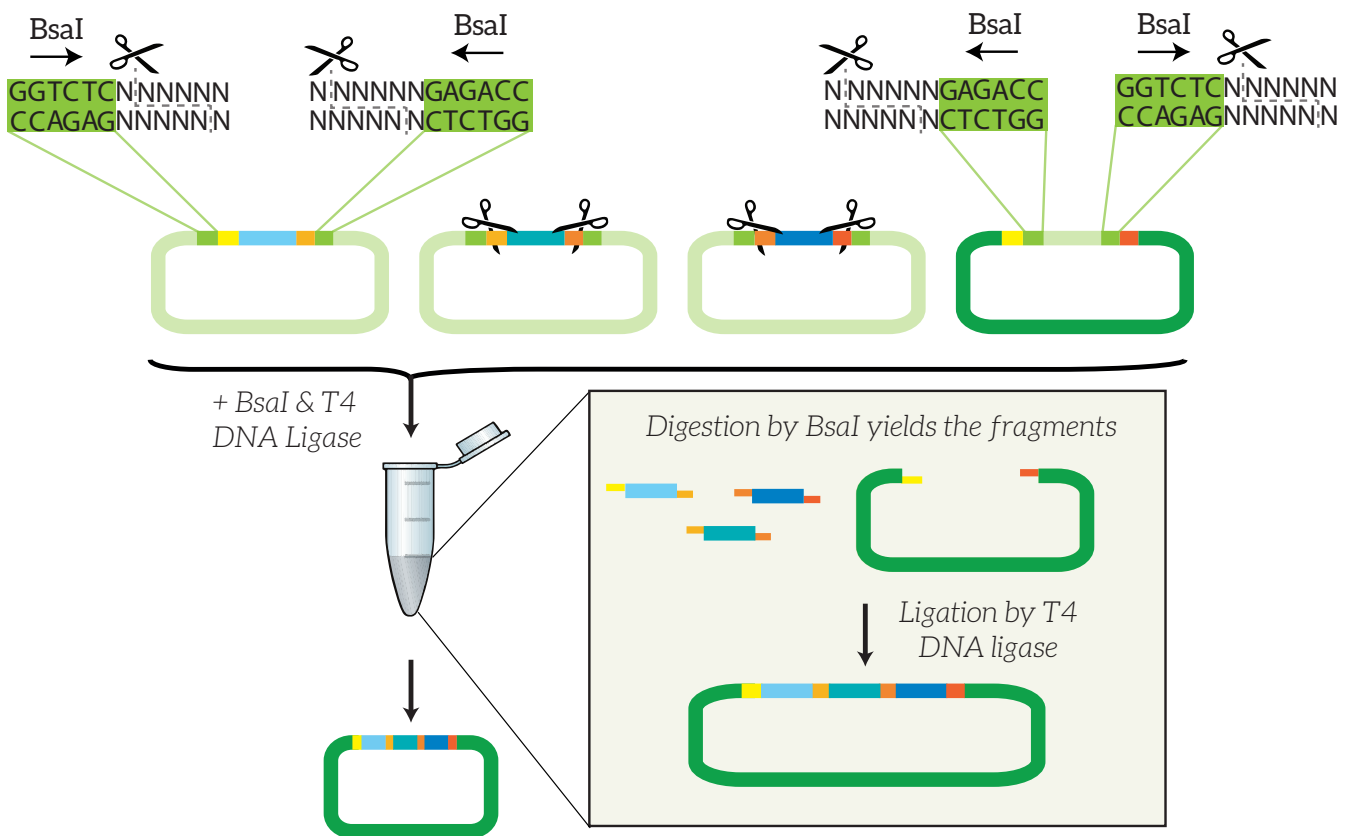

Figure 29 - The one-pot assembly of Golden Gate Cloning features type IIS restriction enzymes which cut outside of the recognition sequence. This yields user-defined overhangs which can be used to assemble multiple parts in a pre-determined order and orientation within a single pot reaction. Different colors of overhangs correspond to different DNA Sequences. The acceptor vector has a different antibiotic resistance to the parts, allowing for the selective formation of the new product.

Note that the inserts and cloning vectors are designed to place the type IIS restriction site distal to the cleavage site, such that the type IIS restriction enzyme removes the recognition site from the assembly. The plasmid cannot be digested again after the Golden Gate Assembly.

## Points of interests

The efficient one-pot one-step reaction can be carried out efficiently as long as:

- Parts are flanked by a convergent pair of type IIS recognition sequences.
- The acceptor has a divergent pair of recognition sequences for the same enzyme.
- There are no other recognition sites for the enzyme in any plasmid backbones or in any of the parts.
- Overhangs created by the type IIS restriction enzymes are unique[2].

## Advantages

- User-defined overhangs yield no scars between the assembly fragments.
- It is time and cost efficient for large constructs as restriction and ligation are performed together[4].
- No PCR or gel purification steps are needed.
- It has no buffer incompatibility as the same enzyme is used[1].

## Disadvantages

- There may be one or several internal BsaI sites in the gene of interest[1].
- It is less sequence independent than overlap-depended methods of assembly. [5]

## Assembly Standards

Golden Gate cloning has been cited in the development of several assembly standards and plasmid tool kits. These assembly standards prevent the final construct from being scarless, but allow for the method to be interchangeable between labs.

The most widely used assembly standards include:

### Golden Braid

For more information, see:

- Sarrion-Perdigones 2011
- Sarrion-Perdigones 2013



### Modular Cloning (MoClo)

The first step in Golden Gate Cloning is to clone level 0 modules. These are basic parts of genetic syntax (e.g. promoters, coding sequences, terminators etc). Each part is flanked with a pair of convergent BsaI restriction sites. Level 1 constructs are made by assembling level 0 modules to make a complete transcriptional unit. The level 1 constructs can then be joined into level 2 or level M constructs with the use of a different type IIS restriction enzyme, BpiI. The process can then be repeated, alternating between the two types of IIS restriction enzyme (see Figure 29) [3].

For more information see:

- Weber 2011
- Engler 2014



## Frequently Asked Questions

- *How long does the entire process take?*

To give a clear idea on the actual time needed when working with this cloning method, take a look at the timeline in Figure 29, describing all the steps and their duration.

- *How many fragments can be inserted and what is the expected yield?*

It is generally admitted that you can clone up to ten fragments in one Golden Gate Assembly, but we never tested it ourselves (iGEM Evry). The table on the right contains arbitrary values as they depend on our own experience.

# Fragments	Yield (%)
1	70
2	50
3	30
4	15
5 or more	<15

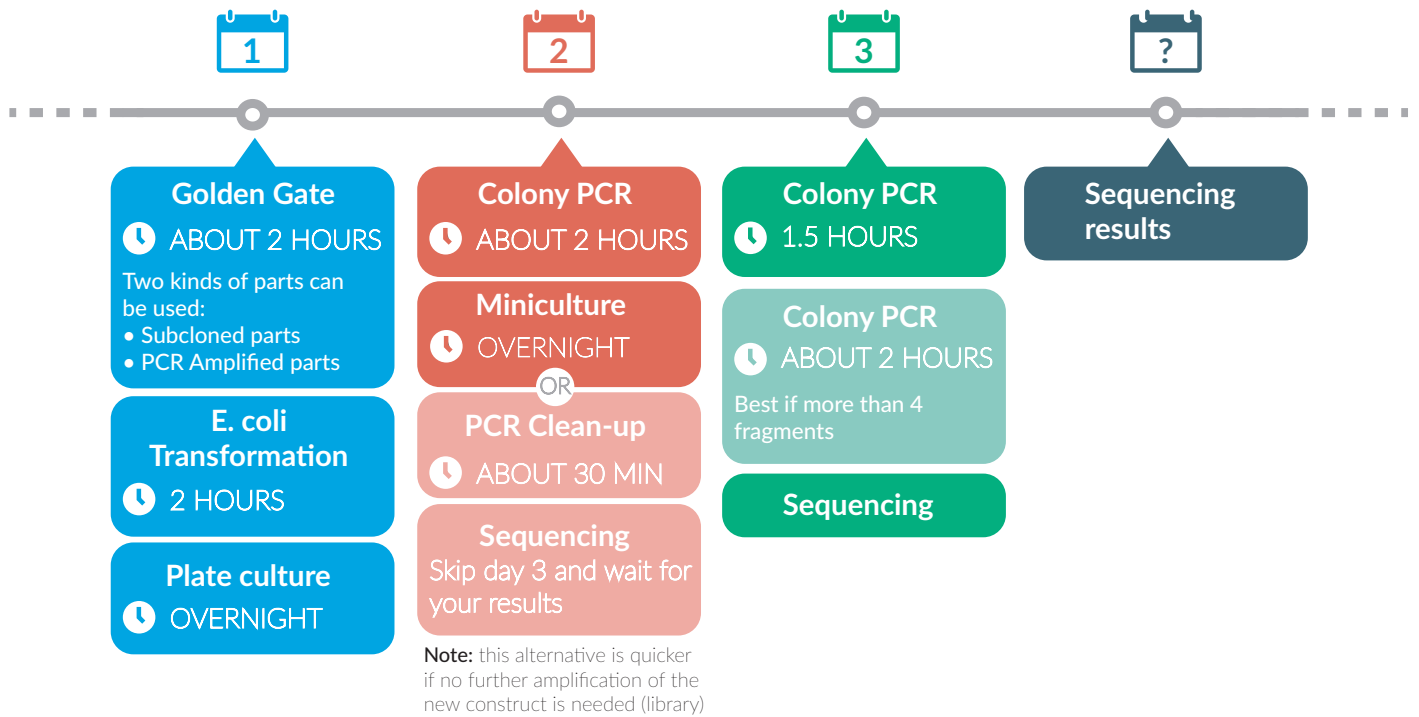

Figure 30 - General timeline of Golden Gate Cloning. Optional or alternative steps are highlighted. It takes about 3 days to obtain transformed colonies when using *E. coli*. This image was made by iGEM Evry.

# NRP-UEA iGEM

## Why Golden Gate?

In 2014, the NRP-UEA iGEM team did the majority of the cloning using Golden Gate Assembly. They also submitted RFC106 that defines standard overhangs for plant parts. We hope to replicate their successes this year.

An important aspect in our project is to test multiple parts in plants. Not only does Golden Gate allow us to rapidly and efficiently test several of these parts together at once, it also gives us more ease when inserting our plasmids into plants. With experience in this form of cloning from previous years, as well as professionals who regularly use Golden Gate Assembly to guide us, we feel confident in using it again this year.

## Materials

- Restriction Enzymes - BsaI (NEB®) and BpiI (Thermo Fisher®) and buffer
- T4 DNA Ligase (NEB®) and buffer
- NanoDrop®
- Electro-competent Cells
- ElectroPorator

## Method

We have done our cloning according to the TSL protocol, which is as follows:

1. Add ATP to the buffer that will be used, as it is required for the T4 ligase to work.
2. Decide which buffer to use (restriction or ligase buffer), as the protocol will differ depend on the buffer. BpiI is required to make level 0 constructs.
3. To make level 0 parts using the ligase buffer, the following was added:
  - a. 100-200ng of acceptor plasmid, plasmids containing each module to be inserted in a 2:1 ratio of insert and acceptor
  - b. 1.5µL of T4 ligase buffer with 200 units of the T4 DNA ligase
  - c. 1.5 µl of Bovine Serum Albumin (10x) and 5 units of BpiI.
4. They are then put in the following conditions:  
20 seconds 37°C, (3 minutes 37°C, 4 minutes 16°C) X26 , 5 minutes 50°C, 5 minutes 80°C, 5 minutes 16°C.
5. To make level 1s, the type of buffer must again be decided. Using the ligase buffer will follow the same conditions as the level 0, but BsaI will be used.
6. To make level 2s, repeat step 3 with the products of step 4 (optional).
7. Use 5 µl of the one-pot dig-lig reaction to transform electrocompetent E. coli cells.
8. Select positive clones using LB agar with appropriate antibiotics.
9. Decide on the primers used for amplification and/or sequencing [7].

## Experiences

- *How did you experience working with this cloning method?*  
The use of this cloning method, in comparison to different methods used by the other members of the team, showed an impressive efficiency with hardly any problems.
- *What was the most difficult task?*  
Designing the level 0 constructs is the most difficult task. After the level 0s are made and work, it's a simple one-pot one-step reaction.
- *Did the cloning method work as expected?*  
The sequence analysis suggests that the cloning of our constructs worked as expected. The fluorescent imaging of our first set of constructs reaffirmed this.
- *What was the biggest achievement using this cloning method?*  
Obtaining our first successful results using Golden Gate Cloning. The confocal microscopy imaging was the final indication our cloning had worked.
- *What would be your tips and tricks if other team are going to use this method?*  
First, it is important to know that Golden Gate is the most appropriate form of cloning for your project. After that, an important piece of advice would be to follow protocols closely. Majority of the time, mistakes happen when shortcuts are made.

## Transfection of plants

Golden Gate Modular Cloning (MoClo) toolboxes have been developed for the transfection of plants. These make efficient transfection of plants possible. iGEM NRP-UEA is the only team featured within the guide focusing on transfection of plants, and has used MoClo to make them generate resistant starch. It is thought that high dietary intake of resistant starch may reduce colon cancer and inflammatory bowel disease.





## The NRP-UEA Team

Our team is made up of 6 undergraduate students from University of East Anglia, along with 3 PhD students and 3 supervisors from Norwich Research Park. This year, we aim to develop butyrate glycogen and starch in light of recent research that indicates these forms of starch could prevent colon cancer. In the distant future, we hope for the possibility of a probiotic to be developed.

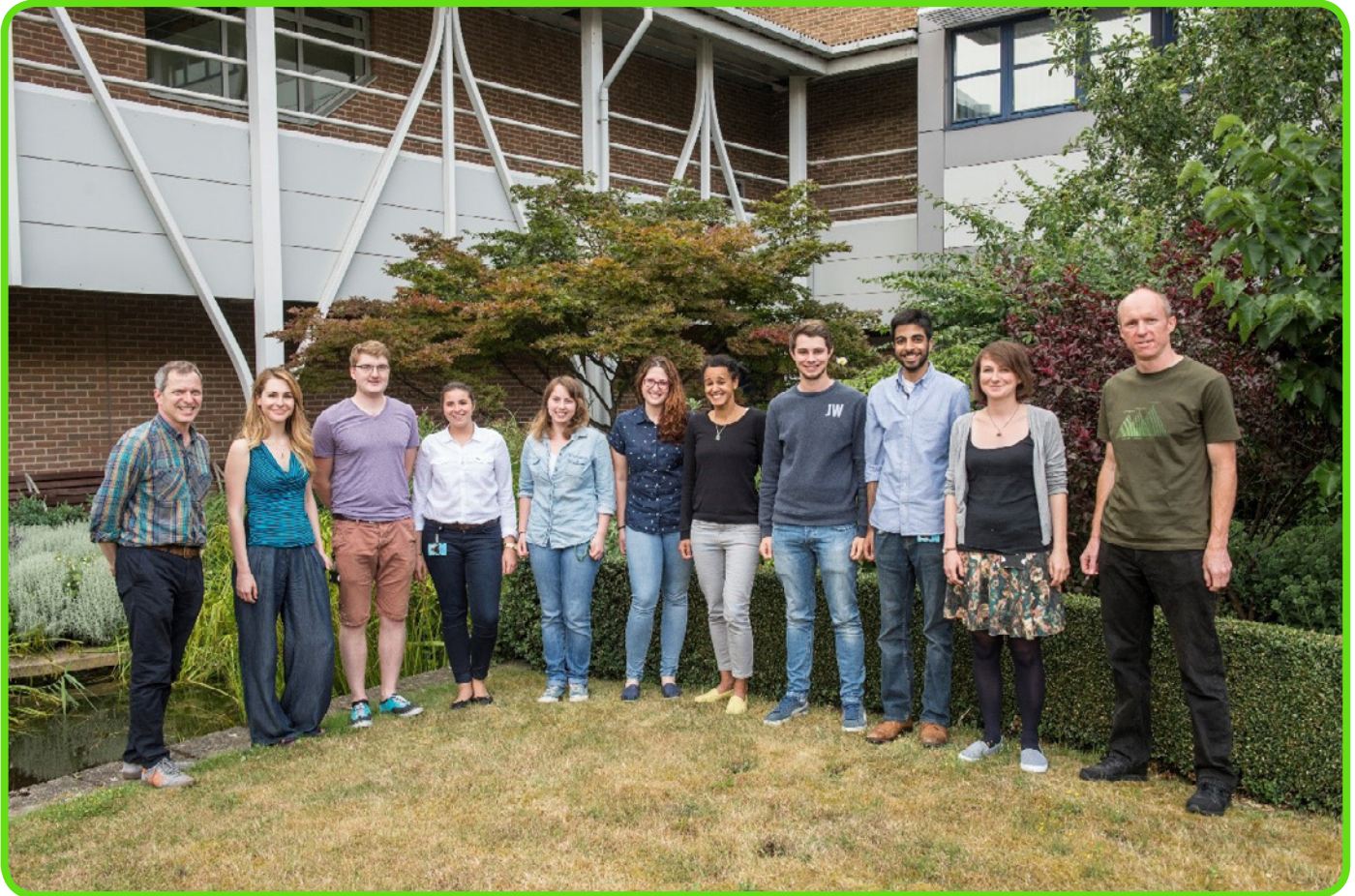

Figure 31 -Photo of the NRP-UEA iGEM Team. From left to Right; Richard Bowater, Eleftharia Trampari, Kieran Rustage, Flavia Valeo, Leda Coelewijn, Pilar Moreno, Nicola Patron, Josh Thody, Farhan Mithia, Sibyl Batey, Mark Banfield. (Not pictured - Mark Riemer-Elms).

## Protocol

This page contains the protocols used by the NRP-UEA team. These protocols include:

- A one-step Golden Gate digestion-ligation protocol
- Restriction digest protocols



# iGEM Evry

## Why Golden Gate?

The Golden Gate Assembly is a fast and simple method to insert one or several fragments into a vector in a single reaction. One of the main advantages is that the overhangs are not depending on the restriction site, such that personalized overhangs can be designed and no scars remain. Thus digestion and ligation can be done simultaneously.

Our team chose to use this cloning method during the iGEM competition because it is, compared to other widespread cloning method, cheap, fast and convenient (single-tube reaction). Furthermore, a lot of people in our lab, including our advisors and members of the previous iGEM teams of Evry, have experience with this cloning method.

## Design Considerations

A few rules must be followed for the overhangs:

- The different overhangs must not be complementary.
- The overhangs must not dimerize (both homodimerization as well as hetero-dimerization).
- They must not be palindromic.
- No more than two of the same bases next to each other.
- They must always end with GC.

### Genes of interest to insert



### Primers with BsaI overhangs



### Genes of interest to insert

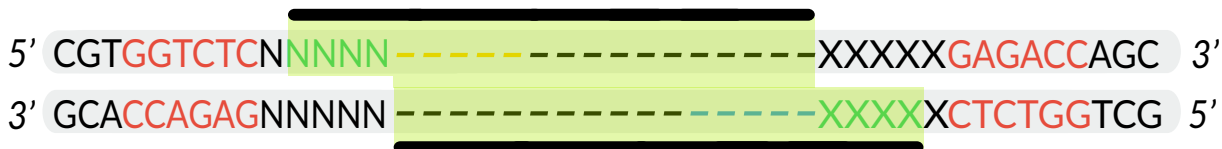

— Amplified gene with designed overhangs

Figure 32 - Overhangs design. This example shows BsaI and uses only one gene of interest. The gene of interest can be amplified with primers with BsaI overhangs to enable Golden Gate Cloning.

## Materials

During our experiments, we used the following:

- Cloning vector with 2 type IIS restriction endonuclease sites flanking a reporter gene. Our team used BsaI.
- Inserts with the same designed sites, such that the overhangs match those on the cloning vectors.
- Type IIS restriction endonucleases.
- T4 DNA Ligase and T4 DNA Ligase Buffer.
- Geneious© software for designing our insert, primers and for almost doing anything on virtual DNA.

## Experiences

- *How did you experience working with this cloning method?*  
This cloning method does not present any major difficulties. Up to 4 fragments can easily be inserted in a single tube reaction with decent transformation yield. The critical step is to design proper primers that fit each other.
- *What was the most difficult task?*  
The bottleneck of this method is the primer design, as there are usually multiple fragments to clone. Apart of this, the Golden Gate method does not present any major difficulties in terms of bench work.
- *Did the cloning method work as expected?*  
Cloning worked as expected, but screening is required after. Indeed, this method is not necessarily as efficient as other cloning methods.
- *What was the biggest achievement using this cloning method?*  
The succes of the cloning itself.
- *What would be your tips and tricks if other team are going to use this method?*
  - o Cloning several fragments, using sub-cloned parts (rather than PCR-amplified parts) helps to get higher yields.
  - o When doing colony PCR, the multiplex method is more reliable in order to check if all your parts were included in the assembly. However it requires that you design a set of primers for each of your parts.
  - o Minipreps are cleaner than PCR clean-up. They produce a better yield and result in more reliable NanoDrop results. If you still want to perform a PCR clean-up, you might prefer to use a gel quantifying method instead of NanoDrop (as the yield is lower).
  - o Keep in mind that even if colony PCR results are encouraging, parts can be counter-selected overnight during miniculture, by recombination as a defense mechanism, especially if you are cloning similar parts.
  - o Make sure that the genes or parts you are working with do not contain any restriction sites of the restriction enzyme you choose.
  - o Use of a reporter gene enables checking if everything was inserted correctly. To confirm succesful insertion a colony PCR can be performed. Sequencing will give the final answer.

## The iGEM Evry team

Our team is composed of 8 undergraduate students from the University of Evry Val d'Essonne and the AgroParisTech engineering school. This year, we are engineering *S. cerevisiae* to modulate the immune response, by acting on the activity of dendritic cells. Our main goal is to produce a synbio-based immunotherapy (presentation of tumoral antigens to the immune system and activation of it).



Figure 33 - iGEM Evry team from left to right (both rows); Julie Zarowski (advisor), Cyrille Pauthenier (advisor), François Bucchini, Pierre-Yves Nogue, Marjorie Aubert, Clément De Obaldia, Louise Barreau, Frédéric Ros

## Protocols

This protocol describes the basic steps of Golden Gate cloning. The link can be scanned in the following QR code.



# iGEM Sydney

## Why Golden Gate?

Golden Gate was chosen as the primary cloning method over other prominent methods such as Gibson Assembly and Traditional Cloning, as we were trying to clone more than one insert into the vector. Even though Gibson Assembly is the preferred method for cloning several inserts into a vector, our team decided to use an alternative method due to mixed reports of success of Gibson Assembly and the fact that each of the inserts were pretty large. Also, we thought it would be exciting to use and test out a novel method.

## Materials

During our experiments, we used the following:

- NEB® BsaI\*/BsaI-HF restriction enzyme (20 U/μL)
- NEB® T4 DNA Ligase concentrated (2000 U/μL)
- NEB® 10X T4 DNA Ligase reaction buffer (500 mM Tris-HCl, 100 mM MgCl<sub>2</sub>, 10 mM ATP, 100 mM DTT, pH 7.5 at 25°C)
- Insert (equimolar amounts to vector)
- Digested PCR linearised vector (e.g. 50 ng)

\* BsaI-HF was used in our experiments; normal BsaI should work as well according to literature.

## Design consideration

The same design protocol as prescribed at the NEB website was followed.

1. If there are 3 inserts, design each end that needs to be put together to contain 4 bp overlapping overhangs.
2. The left hand side overhang of the first insert and the right hand side overhang of the last insert need to overlap with the overhangs of the digested vector.
3. Start by selecting the enzymes you would like to digest your vector e.g. SpeI/EcoRI and design their corresponding overhangs on the inserts to overlap with them.
4. Make sure to place the BsaI recognition site outside of the ORF regions so that it is digested and removed from the final DNA e.g. place it left hand side of the green overhang and right hand side of the light blue overhang.
5. Design primers for PCR linearization of the vector such that they are amplified from a few base pairs upstream of the desired cut sites of the other vector.
6. Double check that all overhangs overlap and are in the correct overhang type of 3' or 5'. In other words, reconstruct the final recombinant vector after drafting your designed inserts and vector.
7. In the thermocycler, the 37°C cycle is for BsaI digestion and the 16°C cycle for DNA ligase to join the overlapping overhangs together.

## Results & Tips

- We discovered that Golden Gate gives mixed results
- For one of our constructs, it successfully joined three 1-1.5 kbp inserts into digested pSB1C3 using the above method
- In the other construct, while the transformation gave positive results, it was discovered that instead of ligating two 2 kbp inserts into pSB1C3, it ligated a 400 bp insert in it (which is the subject of much mystery and speculation)
- Design inserts such that they contain the full ORF not divided between two inserts as this can make the design of overlapping regions complicated.
- Note that the BsaI cut sites are removed after BsaI digestion, hence, the ligated inserts will not be digested again and the BsaI will go on to digest inserts.
- The method works well provided that the following are implemented:
  - Concentrated T4 DNA ligase
  - Use a maximum total volume of 15  $\mu$ L
  - Use equimolar amounts of all inserts and vector (higher ratio may result in mismatched ligation)
  - Make sure that all DNA samples are pure and free of contaminants (miniprep and DNA extraction kits are adequate compared to miniprep)
  - Mix sample by pipetting up and down or gentle tapping
  - Use 5-8  $\mu$ L for transformation
- Overall, we believe that Golden Gate Assembly is a promising method and while it is at its early stages of optimisation and development, it can be a very convenient and effective way of constructing clones with large number of inserts. We hope that by sharing this information, we can make available more information for further optimisation and development of this method.

## Protocols

iGEM Sydney has published protocols for Golden-Gate Assembly on their iGEM Wiki. These protocols include:

- Golden Gate Assembly Protocol
- Golden Gate Assembly design considerations



## The iGEM Sydney team

This year, the Sydney iGEM team is working with the ethene monooxygenase enzyme that performs the epoxide reaction converting ethylene to ethylene oxide. This enzyme is only natively found in *Mycobacterium smegmatis*, however, this host is difficult to work with on an industrial scale. Our main goal is to optimise expression of this enzyme in *Escherichia coli*. More information regarding our team and project can be found in our website [http://2015.igem.org/Team:Sydney\\_Australia](http://2015.igem.org/Team:Sydney_Australia).



Figure 34 -Photo of iGEM Sydney 2015. From left to right: Lizzie, Mark, Gaia, Sandi, Harrison and Mahiar in the middle

References:

[1] C. Engler, R. Kandzia, and S. Marillonnet, "A one pot, one step, precision cloning method with high throughput capability.," *PLoS One*, vol. 3, no. 11, p. e3647, Jan. 2008.

[2] N. J. Patron, D. Orzaez, S. Marillonnet, H. Warzecha, C. Matthewman, M. Youles, O. Raitskin, A. Leveau, G. Farré, C. Rogers, A. Smith, J. Hibberd, A. A. R. Webb, J. Locke, S. Schornack, J. Ajioka, D. C. Baulcombe, C. Zipfel, S. Kamoun, J. D. G. Jones, H. Kuhn, S. Robatzek, H. P. Van Esse, D. Sanders, G. Oldroyd, C. Martin, R. Field, S. O'Connor, S. Fox, B. Wulff, B. Miller, A. Breakspear, G. Radhakrishnan, P.-M. Delaux, D. Loqué, A. Granell, A. Tissier, P. Shih, T. P. Brutnell, W. P. Quick, H. Rischer, P. D. Fraser, A. Aharoni, C. Raines, P. F. South, J.-M. Ané, B. R. Hamberger, J. Langdale, J. Stougaard, H. Bouwmeester, M. Udvardi, J. A. H. Murray, V. Ntoukakis, P. Schäfer, K. Denby, K. J. Edwards, A. Osbourn, and J. Haseloff, "Standards for plant synthetic biology: a common syntax for exchange of DNA parts," *New Phytol.*, p. n/a-n/a, Jun. 2015.

[3] S. Werner, C. Engler, E. Weber, R. Gruetzner, and S. Marillonnet, "Fast track assembly of multigene constructs using Golden Gate cloning and the MoClo system.," *Bioeng. Bugs*, vol. 3, no. 1, pp. 38-43, Jan. 2012.

[4] N. J. Patron, "DNA assembly for plant biology: techniques and tools.," *Curr. Opin. Plant Biol.*, vol. 19, pp. 14-9, Jun. 2014.

[5] "The Golden Gate assembly method (and MoClo and GoldenBraid)." [Online]. Available: <https://j5.jbei.org/j5manual/pages/23.html>. [Accessed: 26-Jul-2015].

[6] C. Engler, M. Youles, R. Gruetzner, T.-M. Ehnert, S. Werner, J. D. G. Jones, N. J. Patron, and S. Marillonnet, "A golden gate modular cloning toolbox for plants.," *ACS Synth. Biol.*, vol. 3, no. 11, pp. 839-43, Nov. 2014.

[7] "Golden Gate Assembly Protocol | SynBio@TSL." [Online]. Available: <http://synbio.tsl.ac.uk/golden-gate-assembly-protocol/>. [Accessed: 26-Jul-2015].

# Yeast Recombination

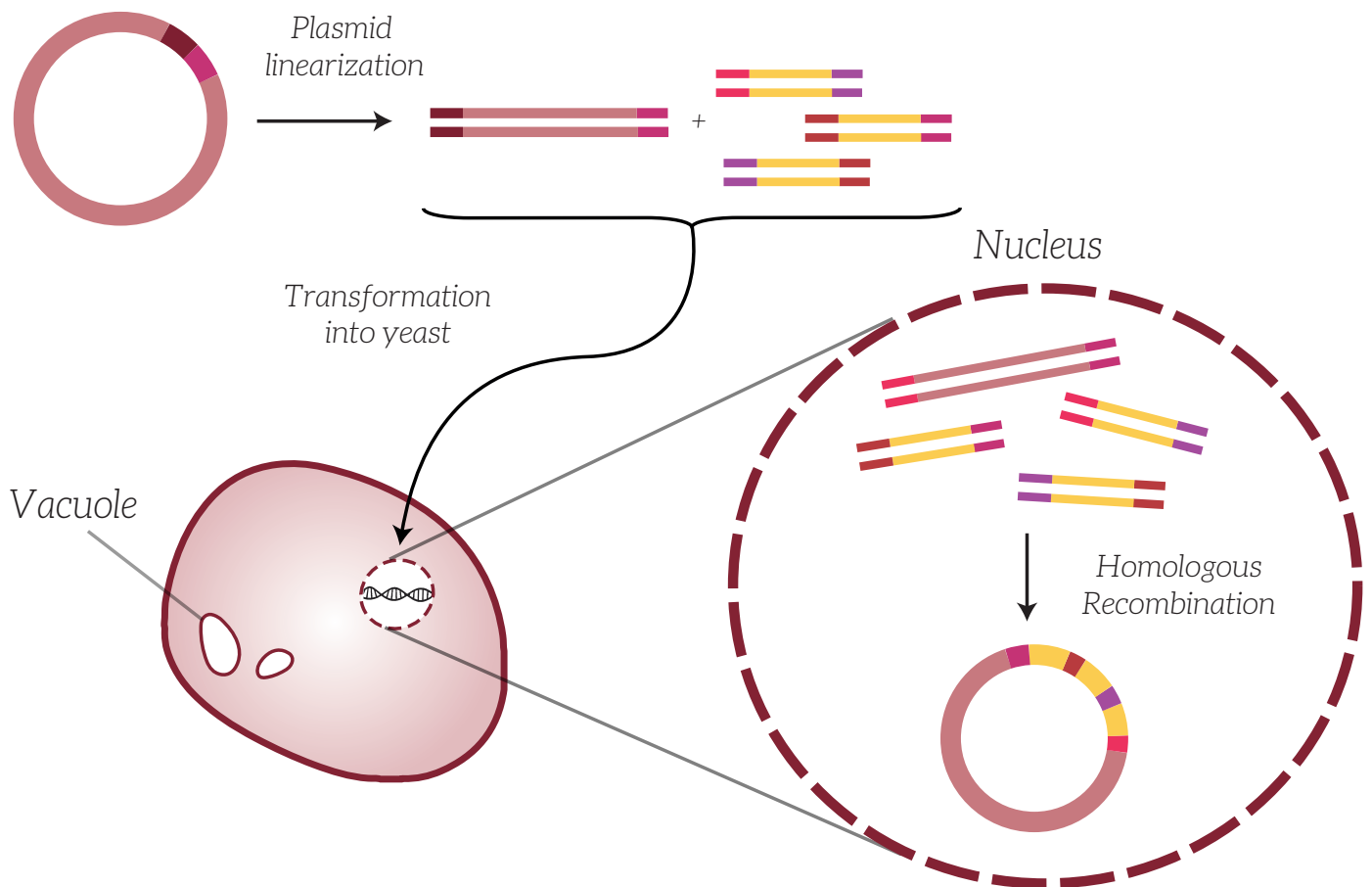

Figure 35 - The first step is to linearize the plasmid either through restriction digestion or PCR amplification. After adding some chemicals to make the yeast competent, add all of the vector and inserts with the weakened yeast and transform the yeast. The inserts and vector will recombine into a plasmid through homologous recombination. PCR screen of the junctions can be used to analyze if the transformation worked.

## Introduction

Homologous recombination is the exchange of DNA strands of similar or identical nucleotide sequences. This genetic recombination was first hinted at in the 1900's when William Bateson and Reginald Punnett noticed that certain traits tended to be inherited together, and then later in 1911 Thomas Morgan noticed that some of these genetically linked traits can be on occasion be inherited separately. This led Morgan to hypothesize that there are crossovers between chromosomes. This was proved to be correct by Barbara McClintock and Harriet Creighton in the 1930's when they demonstrated the crossover during meiosis. As the years progressed it was shown that all three domains of life as well as viruses have this biological mechanism. In 1978, Dr. Hinnen demonstrated that yeast was able to recombine plasmids followed in 1981 by Dr. Orr-Weaver who reported the mechanistic studies of how yeast undergoes homologous recombination [1, 2]. This technique is preferred by eukaryotic cells to repair double stranded breaks as they are able to recover nucleotides that are lost due to the break if the other homologous strand remains less damaged. Yeast, in particular, frequently and efficiently undergo homologous recombination which makes it a good tool to construct plasmids even from multiple overlapping DNA fragments [3-6].



## Points of interests

- Requires linearized eukaryote vector and dsDNA fragments.
- dsDNA need to have an overlapping region of at least 29 base pairs on both sides; 40 base pairs is recommended.
- Overlapping region can be added as part of gene synthesis/gBlock or primers can be used to add the overlapping sequence through PCR if the desired product is already cloned.
- Repetitive sequences greater than 15 base pairs anywhere in the vector or fragments should be avoided to prevent undesired recombination during cloning process or later.
- More fragments decrease efficiency.
- Yeast have a higher level of translation when the Kozak sequence ACC is added before the start codon.

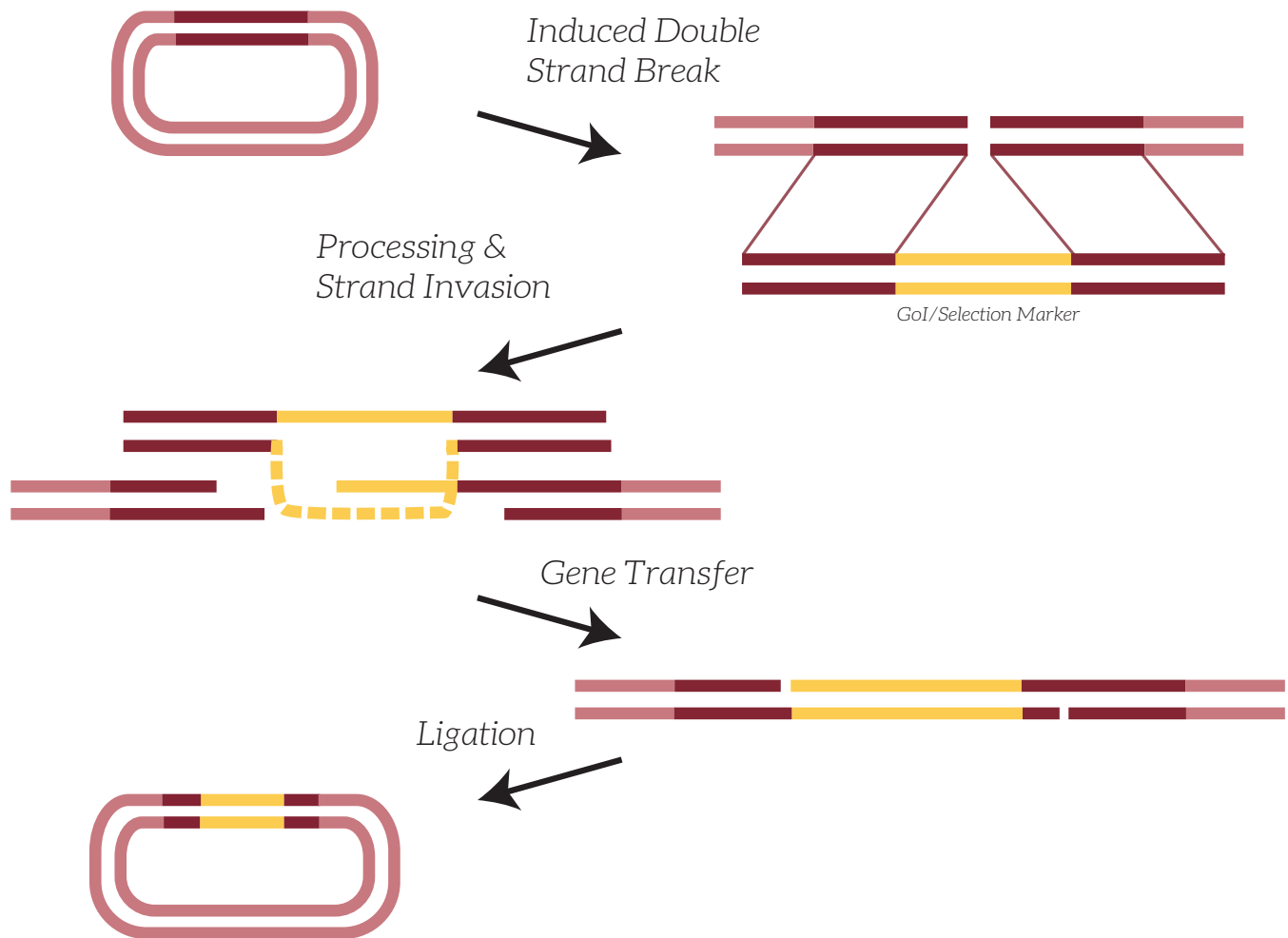

Figure 36 - The first step in homologous recombination (HR) is for the modified inserts to align with homologous regions. A double stranded break will be induced. After some processing of the vector, one of the strands of the insert will invade the space left from the induced break to provide a template to bridge the gap.

## Advantages

- Highly efficient, seamless method.
- No purification steps.
- Only need enzymes and plates; no kits necessary.
- Fragment design similar to Gibson Assembly if yeast recombination does not work.

## Disadvantages

- Several days to finish procedure.
- Difficult to add lengthy tags.
- Need eukaryote vector or yeast origin of replication.
- Efficiency decreases as the number of fragments increase.
- Difficult to interchange fragments in yeast.
- Need a shaker and incubator at 30°C.

## Frequently Asked Questions

- *Does the size of the insert affect recombination efficiency?*  
Yes, increased size of insert will decrease the efficiency because it will increase the plasmid size, which yields lower transformation efficiency. Our mentor Dr. Sarah Perdue was able to transform an 18 kb plasmid into yeast and still had a decent transformation efficiency.
- *How many fragments can be assembled?*  
The biggest achievement was 25 fragments ranging in size from 17 kb to 35 kb [7]; however, we would not recommend trying this as your efficiency tends to decrease as you increase the number of fragments. That being said, it seems that the number of fragments has a greater effect on transformation efficiency than the length of the inserts.
- *How long does the homologous regions have to be?*  
The minimum amount of homology is 30 bp on both sides or 20 bp on one and 80 bp on the other [8]. This being said we used 40 bp because we wanted to be safe.
- *Can I use homologous recombination to add a nucleotide or drop a nucleotide in order to destroy a restriction site in the homologous region?*  
It depends. If the nucleotide is close to the insert (<10 bp away), then there should not be an issue as long as you still have a minimum of 30 bp of perfect homology. If the nucleotide is in the middle or end of the homologous region, you can extend the homology so that there is 30 base pairs of homology before the site.
- *If I PCR my inserts to increase their concentration, do I need to clean-up the PCR afterwards?*  
While we have not tested if this affects our transformation efficiency, the efficiency has been high enough that we have concerned ourselves with testing this.
- *Do I need to purchase a separate miniprep kit for the yeast?*  
By using the lyse yeast solution, we have been able to use the Promega and BioBasic bacterial miniprep kits to extract the plasmids from yeasts starting after the second step, the lysis. This being said, we have noticed that our E. coli transformations seem to have a lower efficiency that expected. This is most likely because of the decreased DNA concentration since yeast grow at a much slower rate than yeast. We doubled our transformations.

## Useful additional information & resources

Minnesota's mentor Dr. Sarah Perdue made her own protocol for yeast recombination by borrowing from the following OpenWetWare protocol. The protocol also has some tips at the bottom.



The Koshland Lab from UC Berkeley published a protocol for Quick Yeast Transformation which formed a source of inspiration for Minnesota's protocols. This is a step-by-step protocol for the yeast transformation.

Addgene, known as the nonprofit plasmid repository, has posted an article on Yeast Vectors. This information can be used if you want to make a yeast vector from any other plasmid by inserting a yeast origin of replication.



# iGEM Minnesota

## Why Yeast Recombination?

Team Minnesota 2015 choose this cloning technique because we need to express our genes in a eukaryotic vector and this is the preferred technique of one of our mentors. While this process has several more steps than other methods such as direct ligation or Gibson Assembly, it tends to have a higher rate of success than other methods. Thanks to the gBlocks® from IDT, it makes this process very easy to use as you can decide how long the homologous sequences are going to be and where the fragments should go. This process has been fairly easy to troubleshoot because yeast uptake DNA and homologous recombine so readily.

## Experiences

- *How did you experience working with this cloning method?*  
It was very interesting working with our cloning method in part because our construct contained a bidirectional promoter. At first it was frustrating because our first two transformations failed; however, once we realized that we had switched our linearized plasmids, we had great (and good smelling) success.
- *What was the most difficult task?*  
Besides dealing with human error, the most difficult task was designing the gBlocks to eliminate illegal restriction sites. Using tools such as ApE or Snapgene to create the final sequence that you want can greatly help to visualize what you are doing.
- *Did the cloning method work as expected?*  
Yes, the yeast recombination seems to have worked well.
- *What was your biggest achievement with the cloning method?*  
We were able to clone 2 fragments totaling 3.3 kb of non-homologous region into a yeast plasmid
- *What would be your tips and tricks if other teams are going to use yeast recombination?*
  - Watch for excessive homology within your inserts as the yeast might perform homologous recombination on that area as well.
  - Once you have successfully transformed the yeast, make sure you keep it on the selective media, otherwise it will eventually kick out the plasmid.
  - If you don't have access to or a budget for purchasing a yeast plasmid, you can make any plasmid a yeast vector by adding a yeast origin of replication and selection marker. This can easily be done by using gBlocks and yeast recombination for only colonies that have the selection marker should survive. For more information on yeast plasmids and selection markers, check out the addgene piece on yeast vectors.

## iGEM Minnesota 2015

We are a team of five undergraduate students from the University of Minnesota, Twin Cities. This year we are studying the use of viral 2A sequences in multi-enzyme biosynthesis. We have developed a mathematical model for optimal gene order.

## Materials

Growing the yeast:

- Auxotrophic yeast strain (ex. CEN.PK2)
- Yeast extract peptone dextrose (YPD) plates

Yeast Recombination:

- Plates with necessary compounds yeast otherwise cannot make
- 1000-2500 ng linearized vector that provides the gene required for the yeast strain (ex. pESC-URA)
- gBlocks offered by IDT®
- 50% PEG 3350
- 1M Lithium acetate (LiOAc)
- 10 mg/mL carrier DNA

Lyse Yeast for Colony PCR Screen

- 2M Sorbitol
- 1M K3PO4
- 20 mg/ml 20T zymolyase

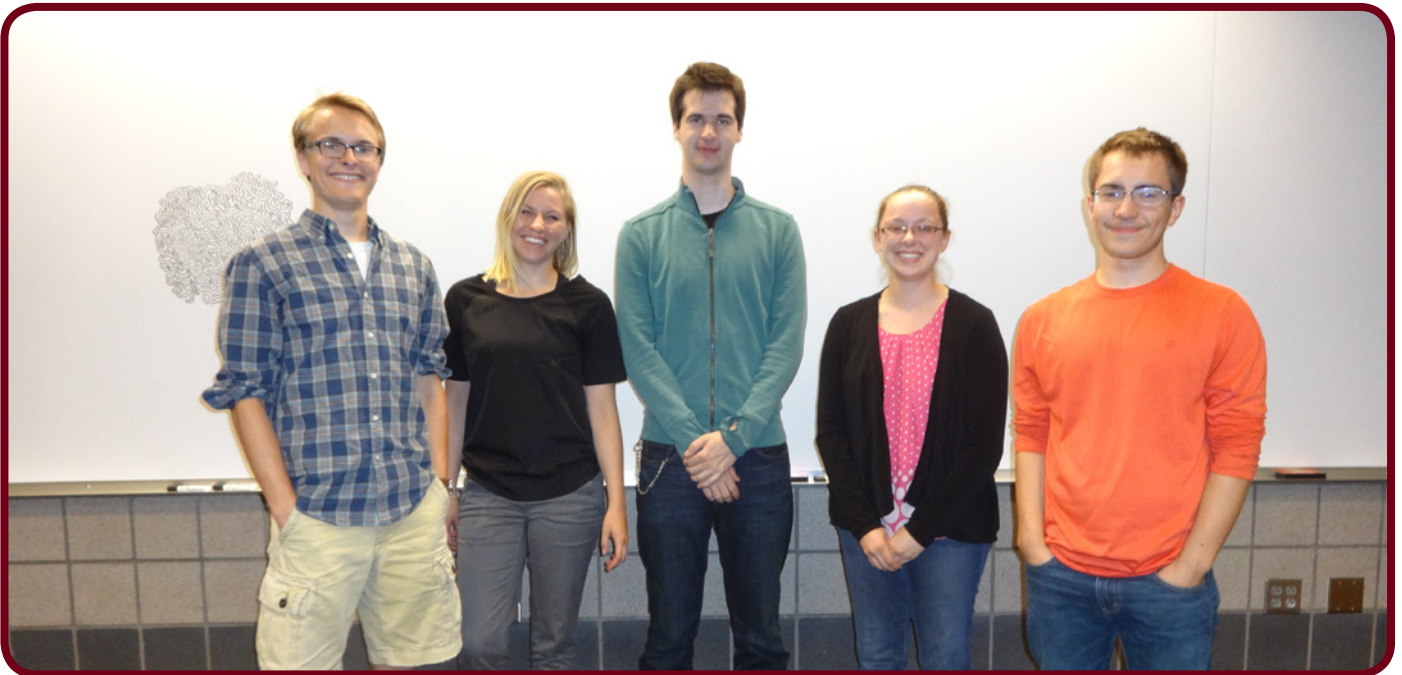

Figure 37: Team minnesota from left to right: Nicholas Nesbitt, Andrea Willgoths, Tanner Cook, Sarah Lucas and Patrick Holec.

## References:

- [1] A. Hinnen, J. B. Hicks, G. R. Fink, Transformation of yeast. *Proc. Natl. Acad. Sci. U. S. A.* 75, 1929-33 (1978).
- [2] T. L. Orr-Weaver, J. W. Szostak, R. J. Rothstein, Yeast transformation: a model system for the study of recombination. *Proc. Natl. Acad. Sci. U. S. A.* 78, 6354-8 (1981).
- [3] H. Ma, S. Kunes, P. J. Schatz, D. Botstein, Plasmid construction by homologous recombination in yeast. *Gene.* 58, 201-16 (1987).
- [4] C. K. Raymond, T. A. Pownder, S. L. Sexson, General method for plasmid construction using homologous recombination. *Biotechniques.* 26, 134-8, 140-1 (1999).
- [5] D. L. Marykwas, S. E. Passmore, Mapping by multifragment cloning in vivo. *Proc. Natl. Acad. Sci. U. S. A.* 92, 11701-5 (1995).
- [6] T. Ebersole et al., Rapid generation of long synthetic tandem repeats and its application for analysis in human artificial chromosome formation. *Nucleic Acids Res.* 33, e130 (2005).
- [7] D. G. Gibson et al., One-step assembly in yeast of 25 overlapping DNA fragments to form a complete synthetic *Mycoplasma genitalium* genome. *Proc. Natl. Acad. Sci. U. S. A.* 105, 20404-9 (2008).
- [8] S. B. Hua, M. Qiu, E. Chan, L. Zhu, Y. Luo, Minimum length of sequence homology required for in vivo cloning by homologous recombination in yeast. *Plasmid.* 38, 91-6 (1997).

# TOPO-TA Cloning

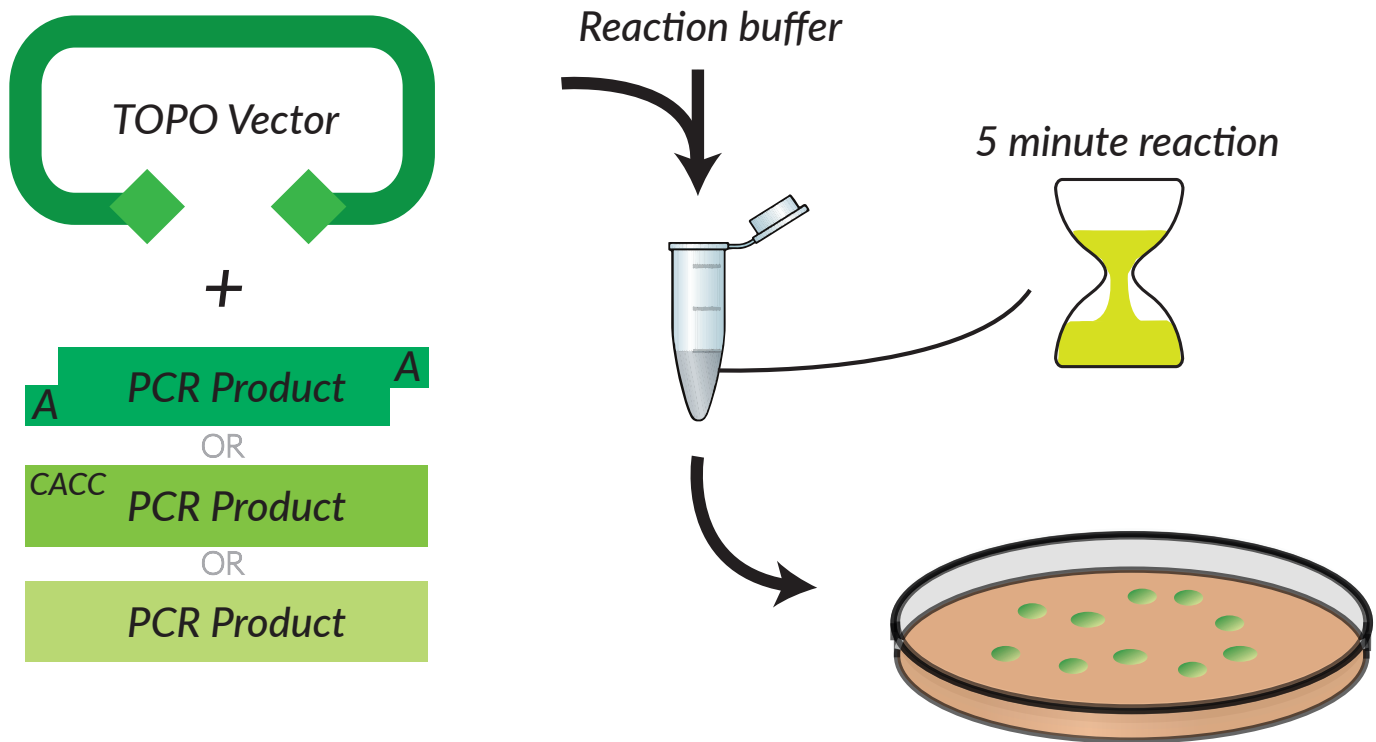

Figure 38: Overview of general TOPO cloning. Combine your PCR product with the applicable TOPO cloning vector in the provided reaction buffer and incubate for 5 minutes. Topoisomerase I (purple diamond) relegates the PCR product to the TOPO vector, while detaching itself during the process. Now that your cloning vector is ready you can transform it into your competent cells for further applications.

## Introduction

Over the past two decades, TOPO cloning has become one of the most reliable techniques in the field of cloning.

The technique's key element is the DNA Topoisomerase I which biologically fulfills the role of cleaving and rejoining the DNA during replication. Topoisomerase I from Vaccinia virus cleaves a single strand of dsDNA by specifically reacting with the phosphodiester backbone of a 5'-(C/T)CCTT-3' sequence. The energy that this reaction releases is then conserved and applied to the formation of a covalent bond between a tyrosine (Tyr-274) of the topoisomerase and the phosphate group attached to the 3 prime end. As it cleaves only one DNA strand it enables the unwinding of supercoiled DNA molecules. The 5' hydroxyl is able to reverse the reaction that resulted in the initial binding of DNA Topoisomerase I, subsequently relegating the single strand.

Additional to the principle of DNA Topoisomerase I, TOPO-TA is a one-step cloning strategy that is built upon the principle of Taq Polymerase. This specific polymerase adds a single adenine (A) to the 3' ends of PCR products, creating a mononucleotide overhang. The TOPO-TA kit provides a linearized vector with a mononucleotide thymine (T) overhang which allows the PCR product to ligate with the vector. (Figure 39)

## Points of Interest

- TA cloning (without topoisomerase) already had a good reputation as a reliable cloning technique as it was first used in 1990 by T.A. Holton [3].
- TOPO-TA technology is trademarked by Thermo Fisher, making them the only supplier. Because of this the available vector types is decreased to 2.
- PCR products from primers with 5' phosphates DO NOT ligate in the vectors.
- Post-amplification with Taq Polymerase can create the necessary A-overhangs if your PCR product contains blunt ends.

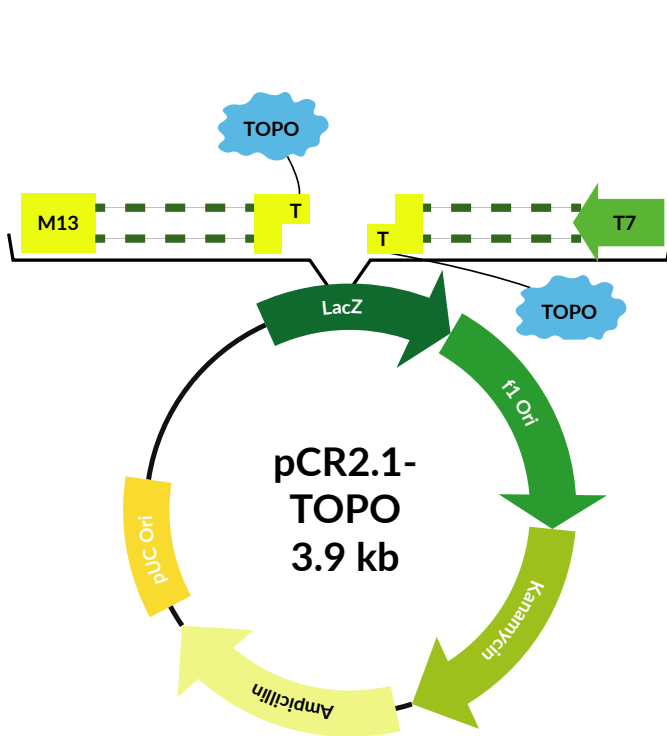

Figure 39: pCR2.1-TOPO  
pCR2.1 comes with a selective LacZ marker that remains functional if the plasmid relegates with itself. Successful ligation of PCR product in the pCR2.1 vector disrupts the lacZ gene which results in white colonies.

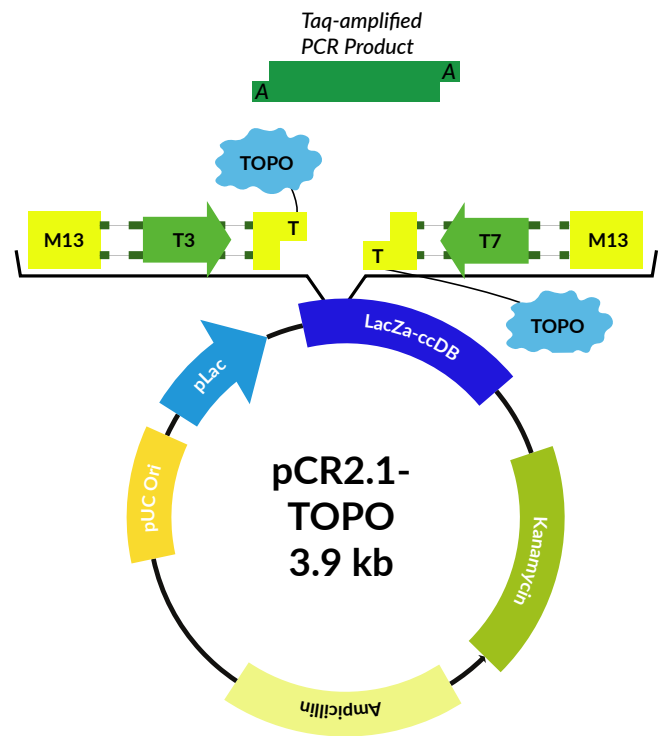

Figure 40: pCR4-TOPO  
pCR4 comes with a LacZ-ccdB marker of which the lethal E.coli gene ccdB gene is fused to the C-terminus of the LacZ gene. Ligation of PCR products disrupts the fused gene's expression, allowing growth of the transformants.

## Advantages

- Specific binding of PCR product to vector due to overhangs.
- As if 5 minutes wasn't already fast, TOPO-TA can produce successful ligations in 30 seconds.
- EcoRI sites flank the PCR product insertion site in both vectors for easy excision of inserts.
- Selection of cells is based on antibiotic resistances (Amp and Kan) and LacZ(-ccdB) screening.

## Disadvantages

- TOPO-TA is expensive, starting at €209,- for 10 reactions.
- TOPO-TA is not directional, although TOPO directional cloning kits are available.
- Limited choice of vectors.

## Possible applications of TOPO-TA cloning

- Subcloning:  
As confirming successful terminal restrictions are hard to confirm on PCR fragments, pCR2.1-TOPO offers 15 convenient and validated restriction sites flanking the region of insert. Gel electrophoresis would subsequently confirm a successful digestion.
- Sequencing:  
pCR4-TOPO contains 4 priming sites (T3 and T7, M13 Reverse and M13 Forward (-20)) and as the cloning kit comes with the associated primers it enables the user to verify that the genes are ligated in the correct orientation.

## Frequently Asked Questions

*What if our PCR products only have blunt ends?*

Blunt-ended fragments can still be post-amplified by incubating them with Taq Polymerase to acquire the necessary A' overhangs. It is best to do this post-amplification right before you intend to TOPO-TA cloning.

- *Can I use a DNA Polymerase mixture containing both Taq Polymerase and a proofreading polymerase for TOPO-TA cloning?*  
It is possible to use a pre-mixed polymerase mixture as long as the ratio between Taq Polymerase and proofreading polymerase is 10:1.
- *Is it possible to clone our gene directionally?*  
Aside from TOPO-TA, Thermo Fisher offers multiple other TOPO cloning kits for longer PCR fragments (3-10 kb), blunt-ends and directional cloning.
- *Are there alternative TOPO-vectors than those of Thermo Fisher?*  
Unfortunately Thermo Fisher is the only supplier of TOPO-vectors. Although there are new technologies on the rise (with independent scientists or even companies) on the internet, currently the most reliable option is Invitrogen's 'Custom TOPO Adaptation Service' which allows you to send in a glycerol stock of E. coli with your plasmid of which a TOPO vector will be made.

## Usefull additional information & resources

- General overview of TOPO cloning: Invitrogen life technologies has compiled the advantages of TOPO TA Cloning over traditional cloning within this folder. Moreover, it describes extensively how TOPO TA Cloning works.
- Custom TOPO Adaptation: This powerpoint presentation by ThermoFisher gives a detailed description of TOPO TA Cloning, further applications of TOPO TA Cloning.



# iGEM Bonn

## Team iGEM Bonn

Our international team of students comes from a variety of biological studies at the University of Bonn and the Hochschule Bonn-Rhein-Sieg. We research the recycling process of the most common natural resource, paper. As synthetic biology offers a novel, clean and even more efficient approach compared to common chemical procedures, we aim to facilitate and contribute to innovation.



Figure 41: Team photo of iGEM Bonn behind the LIMES Institute. Top row from left to right: Benedikt Hölbling, Balthasar Schlotmann, Ashwin Shah, Pavel Ryzhov, Jan Hansen, Niklas Schmacke. Bottom row from left to right: Katrin Ciupka, Max Schelski, Cathleen Hagemann, Alena Sommer, Guido de Boer, Mariya Chernyavska, Sophia Mädler

## References:

- [1] Thermo Fisher (2015) TOPO Cloning Technolog. Brochure.
- [2] Sigma Aldrich (2015) Topoisomerase I from Vaccinia Virus. Datasheet.
- [3] Holton, T.A., Graham, M.W. (199). A simple and efficient method for direct cloning of PCR products using ddT-tailed vectors. *Nucleic Acids research*, Vol. 19, No. 5, 1156



# Overlap Extension PCR

## Introduction

Today, many different cloning methods are available among several show high efficiency and reproducibility. Despite these great attributions, most of these cloning methods rely on the usage of at least one restriction enzyme. The introduction of restriction enzymes in the parts may cause issues for the overall construct such as restriction scarring.

Kary Mullis received the Nobel Prize in Chemistry in 1993 for his invention of the Polymerase-Chain Reaction (PCR). This discovery has accelerated the field of molecular biology immensely. PCR methods have been shown to be eligible for side directed cloning of DNA fragments into plasmid backbones. Several different approaches have been developed in recent years such as TA-Cloning, Ligation-independent cloning and Overlap-Extension PCR (OE-PCR). Most of these PCR-based cloning methods are very straight forward and easy to apply. Their independence of restriction enzymes makes them an interesting alternative to traditional cloning methods.

OE-PCR represents one of the most interesting and most straight forward PCR techniques when it comes to cloning methods. The basic principle can be described as a two-step method: (1) Synthesis of your insert fragment with corresponding flanking regions to the insertion location on the vector on both sides (the 5' and 3' end respectively) of the insert and (2) side-directed insertion of the flanked insert into the target plasmid. This approach is also described as circular polymerase extension cloning. In this guide, we want to introduce the general principle of OE-PCR, their advantages, their limitations and tips about how to improve your OE-PCR cloning method.

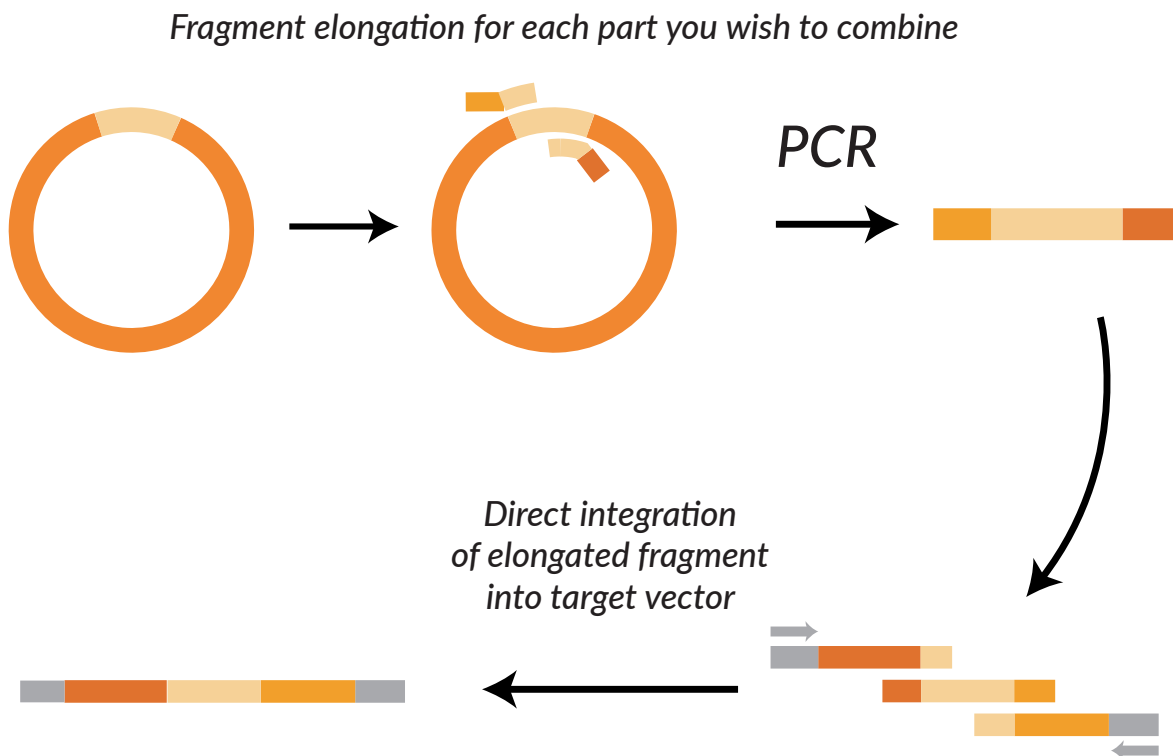

Figure 42: Traditional OE-PCR for synthesis of recombinant fragments. In this traditional usage of OE-PCR, you would need to use PCR amplification to isolate the 5' and 3' fragment as well as the middle piece connecting the two fragments. By extending each of these fragments with 25-27bp of the corresponding neighboring sequence, you can easily assemble different parts together. This approach represents a very powerful tool to create new chimeric biobricks.

## Points of interest

- Flanking regions should be 25-27 nucleotides long at each end.
- Prior linearization of the plasmid can help to promote better assembly of insert and vector
- The insert (dsDNA fragment) is used as a primer with corresponding flanking regions to the insertion site.
- High Fidelity Polymerases show higher PCR efficiency.
- High concentrations of insert and a relatively lower melting temperature (5-10°C under melting temperature) can show higher efficiency.
- The restriction enzyme DpnI can be used to degrade the maternal template in order to increase transformation efficiency.
- 15-30 cycles can be used. Studies show that at around 17 cycles, the OE-PCR efficiency is the highest.

*Fragment elongation for each part you wish to combine*

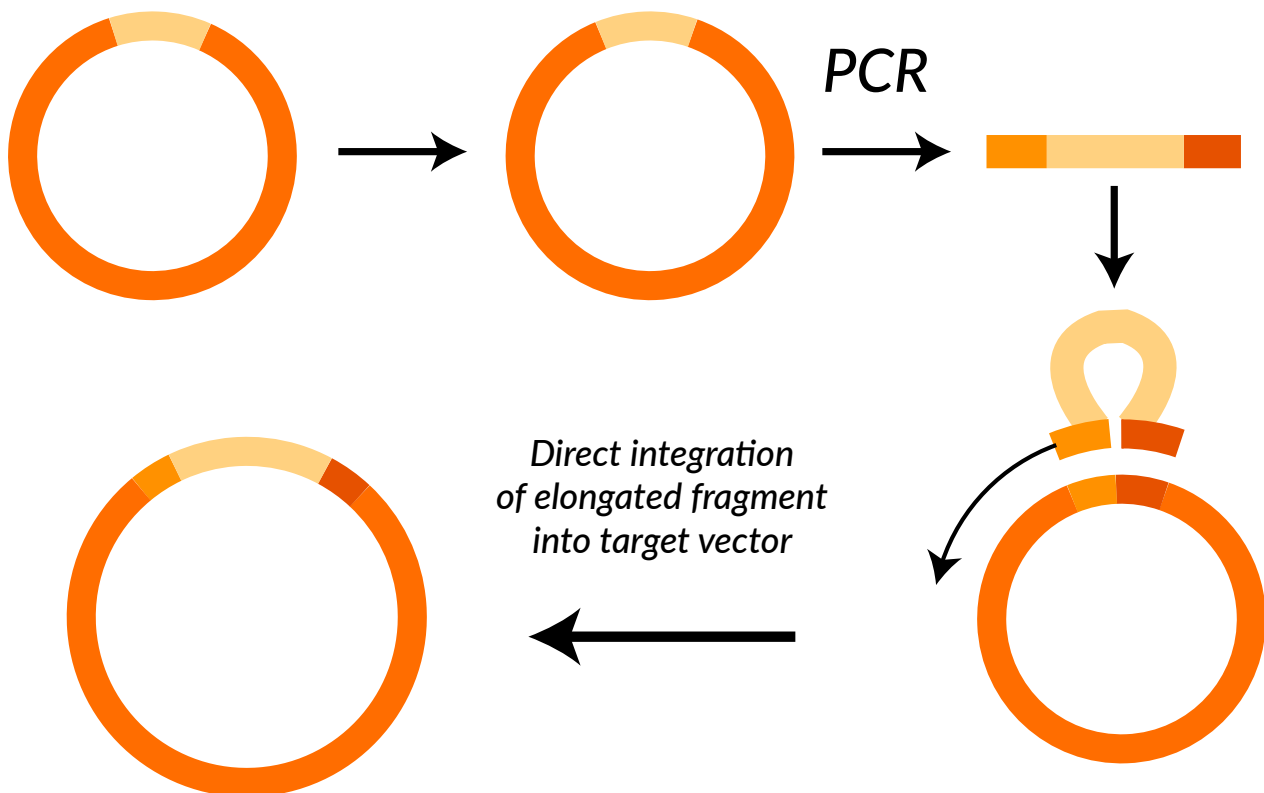

Figure 43: One Fragment OE-PCR for direct integration of a flanked insert into target vector. OE-PCR represents also a very powerful tool if you want to study a protein in an alternative version in a pre-set expression vector. You can insert or delete specific regions in the expression vector of your choice by designing specific primers with corresponding flanking regions. In the example shown above you can insert any sequence whilst amplifying the whole plasmid.

## Applications

This technique is a primary tool for site specific mutagenesis such as altering nucleotides, introducing deletions or insertions into specific sequence locations. However, it is also possible to clone with this technique longer genes into a plasmid which has prior been fragmented into smaller parts.

## Advantages

- OE-PCR allows side directed mutagenesis/cloning of short fragments into specific vector positions.
- OE-PCR does not rely on restriction enzymes or ligation.
- OE-PCR is a very straight forward technique and easy to understand and perform.
- OE-PCR is highly efficient when a high-fidelity (HF) polymerase and the right PCR conditions are used. HF Polymerases with 3'-5' proofreading activity such as Pfu, Phusion or Q5 are most recommendable.
- Only few reagents are needed to perform OE-PCR cloning such as HF-polymerase, dNTPs, PCR Buffer, flanked insert, vector and ddH<sub>2</sub>O.
- After performing OE-PCR, the insert will be found directly in the target vector and ready for characterization or further applications.

## Disadvantages

- Using long inserts (up to 100 nucleotides in length) can lead to unspecific annealing and to false-integration.
- Necessity for restriction digestion (not very reliable) or sequencing.
- PCR smears can arise from wrong PCR conditions: too stringent (primer fails to anneal) or too relaxed (non-specific priming). Hence, PCR conditions can sometimes be a lot of trial and error.
- Repetitive sequences can be troublesome for creating insert or for integrating into target vector.

## Design considerations

1. Design specific elongation primers (60-80 bp is optimal) with which you can extract the insert sequence from genomic DNA or a plasmid backbone. Adjust the primers that they have approximately the same melting temperature. The flanking regions (25-27 bp) to the insert sequence need to be homologous to the sequence of the target vector.
2. Simulate the PCR reaction in Snappene® to confirm the feasibility of your OE-PCR.
3. Perform a high-fidelity PCR by using for example Q5-High Fidelity Polymerase Master Mix and purify the PCR product by first digestion with DpnI and the purification of the desired PCR product either by gel electrophoresis or using the PCR purification Kit from QIAGEN®.
4. The purified flanked insert fragment can now be used as primers for whole plasmid amplification of the target vector. In this PCR, you should again use a high-fidelity polymerase as they achieve better results in cloning efficiency and how mutations rates.  
Recommended: The parental plasmid can be digested with DpnI to reduce the background.  
Recommended: You can also first linearize the target plasmid with the corresponding flanking regions at the end. This may be especially useful while having long target plasmids (> 5 kbp).
5. Purify the plasmid after DpnI digestion using the PCR purification Kit from Qiagen®. This can then be used for transformation. Yields of more than >60% are normally to expect but dependent highly on the construct, sequence, flanking regions and tertiary structure.  
Recommended: Colonies should be sequenced to exclude the possibility of point mutations.

# iGEM Stockholm

## Why Overlap Extension PCR?

We wanted to create a novel chimeric receptor for which we wanted to integrate a molecule within the sequence of another protein. After we failed to synthesize the chimeric protein via the IDT DNA Service, we had to look for other possibilities and found OE-PCR. We needed a method which is not relying on restriction enzymes as we didn't want to create any scarring. OE-PCR seemed to be the appropriate tool to engineer quickly and easily our constructs. We created within one week most of our planned chimeric constructs which shows that with a bit of preparation, this technique is quite easy to apply and shows tremendous cloning efficiency.

## Experiences

- *How did you experience working with this cloning method?*  
After we have been quite disappointed by the service of IDT in synthesizing our long gene fragments, we were quite eager to see that this technique showed to be rather simple and we could construct our chimeric proteins in a functional plasmid backbone in a short time. It is not easy to find the right PCR conditions for all inserts and overlap integrations, but over time you will get a very good feeling at which temperature the melting temperature needs to be set and what the elongation time should be. However, you should be very careful when you want to integrate repetitive sequences. Those show that the yield of your PCR will reduce dramatically.
- *What was the most difficult task?*  
The most difficult task was the design of proper primers for your OE-PCR. We recommend you to take one or two days to sit and try different variants of the primers and to play the scenarios through in silico using Snapgene®.
- *Did the cloning method work as expected?*  
It worked as mentioned very well for us and as expected with the one construct which contained repeating sequences, we had really hard times synthesizing it. However, it is doable.
- *What was the biggest achievement using this cloning method?*  
We cloned within a week all three genetic chimeric constructs into a functional plasmid with which we could start precise characterization right away. We could catch up on time that we lost in prior parts of the project.
- *What would be your tips and tricks if other teams are going to use this method?*
  - Take your time and prepare your OE-PCR carefully. Think about how many mismatches you can accept in the 3' area of your primer and whether the 5' elongation part could partially hybridize in other parts of the plasmid.
  - Use DpnI and the PCR purification kit to increase your yields (especially when having several fragments that you want to clone together).

## Materials

1. The Q5-High Fidelity DNA Polymerase Master Mix offered by New England Biolabs®.
2. Snapgene®, especially its “Overlap Extension-PCR” action for in silico simulation.
3. Appropriate primers to extend insert with flanking regions.
4. Insert sequence vector (from which insert sequence is extracted).
5. Target vector (for integration).
6. PCR purification Kit from Qiagen®.
7. PCR machine with high performance (e.g. Eppendorf Mastercycler nexus).
8. Sequencing Service such as Sanger Sequencing (e.g. GATC Biotech®).
9. Optional: DpnI Restriction Enzyme to lower colony background (e.g. NEB®).

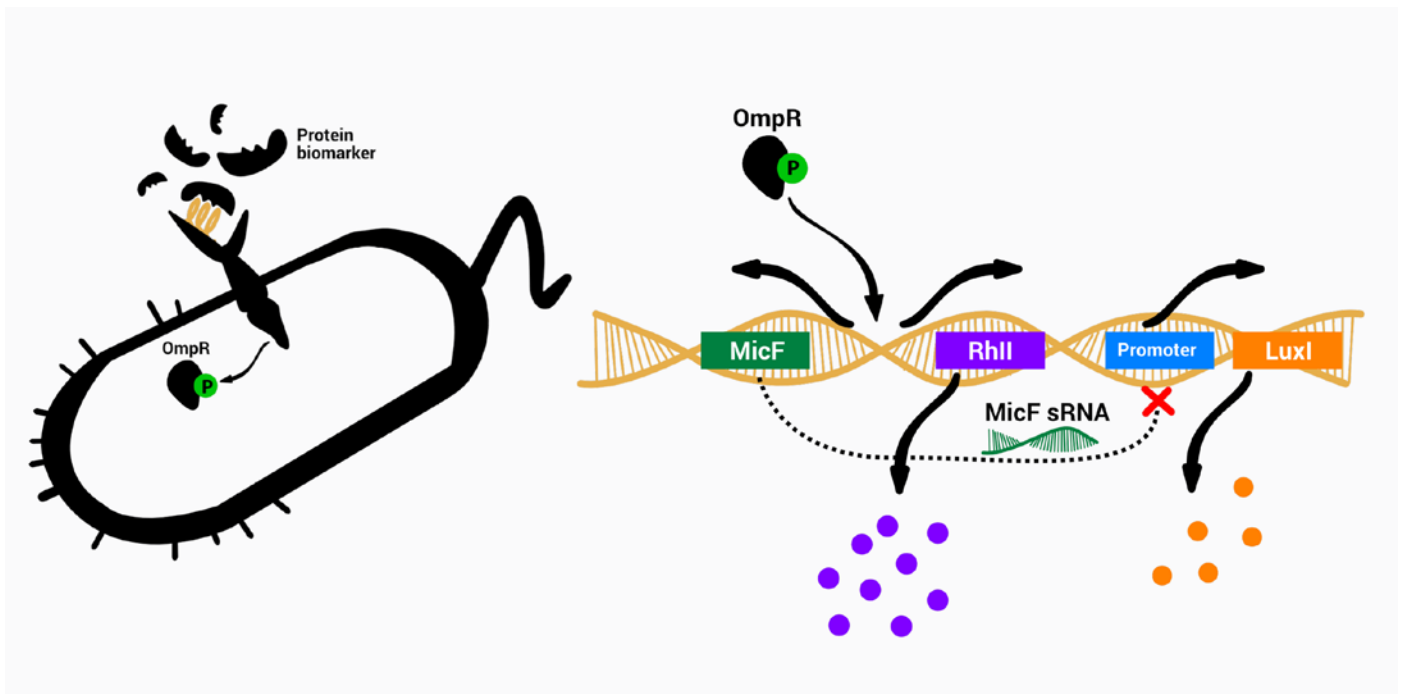

Figure 44: One of the example signaling pathways used by iGEM team Stockholm. The Overlap Extension PCR has to be performed to do further research on examples as pathways.

## Protocols

The following QR code will direct you to the protocols used by our team. These protocols have been based on other protocols already existing for OE-PCR.



## iGEM team Stockholm

Our team consists of eighteen undergraduate and overgraduate students from Karolinska Institutet and KTH Royal Institute of Technology who are coming from five different educational backgrounds and are united in the vision to find new ways for early disease detection. Hence in 2015, we were exploring a novel way to detect selectively and sensitively biomarkers in different body fluid samples. A new class of chimeric receptors derived from the strong peptide binder, the Affibody molecule, and the bacterial membrane receptor EnvZ should sensitize bacteria and trigger a signal amplification cascade.



Figure 45: Team photo of the Stockholm iGEM team 2015. From back to front; Hugi Ásgeirsson, Maximilian Karlander, Pontus Höjer, Karol Kugiejko, Radoslaw Gora, Sarah Wideman, Carmen Gallo Álvarez, Manon Ricard, Linnea Österberg, Alison Shea Baxley, Utsa Karmakar, Felix C. Richter. Not in the picture; Denise Strand, Naz Karadag, Katrine Horne Iversen, Mona Hassan, Hugo Morales Tello, Axel Bergenstråle

### References:

- [1] M. a Shampo and R. a Kyle, "Kary B. Mullis—Nobel Laureate for Procedure to Replicate DNA," *Mayo Clin. Proc.*, vol. 77, no. 7, p. 606, Jul. 2002.
- [2] M. I. Bryksin A., "Overlap extension PCR cloning: a simple and reliable way to create recombinant plasmids," *Biotechniques*, vol. 29, no. 6, pp. 997–1003, 2012.
- [3] W.-G. Luo, H.-Z. Liu, W.-H. Lin, M. H. Kabir, and Y. Su, "Simultaneous splicing of multiple DNA fragments in one PCR reaction.," *Biol. Proced. Online*, vol. 15, no. 1, p. 9, 2013.
- [4] A. Urban, "A rapid and efficient method for site-directed mutagenesis using one- step overlap extension PCR," *Nucleic Acids Res.*, vol. 25, no. 11, pp. 2227–2228, Jun. 1997.
- [5] K. L. Tee and T. S. Wong, "Polishing the craft of genetic diversity creation in directed evolution," *Bio-technol. Adv.*, vol. 31, no. 8, pp. 1707–1721, 2013.
- [6] K. L. Heckman and L. R. Pease, "Gene splicing and mutagenesis by PCR-driven overlap extension.," *Nat. Protoc.*, vol. 2, no. 4, pp. 924–932, 2007.



